

POSTAL BULLETIN

PUBLISHED SINCE MARCH 4, 1880

PB 22049, May 3, 2001

All international air or surface Parcel Post now requires a signature.

Trust your scanners

When you scan the barcode or manually enter the article number, the handheld scanner will let you know the steps to follow. If you're ever in doubt, just follow the prompts on the scanner and then ask your supervisor.

When scanning international Parcel Post at delivery, you will notice that your handheld scanner now prompts you to obtain the recipient's signature on a PS Form 3849, *Delivery Notice/Reminder/Receipt*. Our agreements with the Universal Postal Union require us to capture a signature for all international Parcel Post, both insured and ordinary. Even though some of these items have the Delivery Confirmation™ text above the barcode, a signature is still required. Many countries do not use bar-coded labels on Parcel Post, but use either a label or a stamp with a number written in. After you manually enter a non-bar-coded international article number, the scanner will display a screen that asks whether this is an international mail piece or COD. When you indicate that it is international, you will be prompted to obtain the recipient's signature.

Some international items that are **NOT** Parcel Post require scanning, but no recipi-

ent signature. Xpresspost-USA flats from Canada are a good example. When these items are scanned, you will not be prompted to obtain a signature.

For international items, just remember to:

- Scan or enter the article number,
- Enter the appropriate event, and
- Follow the prompts on your scanner screen.

POS ONE does not currently collect a signature for these items. Until it does, when customers pick up international Parcel Post at a POS ONE terminal, simply follow the current process. Do not use a handheld scanner to collect a signature at a POS ONE retail window.

When customers pick up international Parcel Post at the retail counter in an IRT or manual office, use the handheld scanner as described above.

INTERNATIONAL BUSINESS

CONTENTS

The *Postal Bulletin* is also available on the World Wide Web at <http://www.usps.com/cpim/ftp/bulletin/pb.htm> for customers and at <http://blue.usps.gov> for employees.

International Business — Trust Your Scanners	1
Administrative Services	
Handbook Revision: AS-551, <i>Clean Air Act Compliance Guide</i>	3
Correction: PS Form 153, <i>Signature Confirmation</i>	4
Customer Relations	
Mail Alert	4
All Offices With City Motorized, Rural, and Highway Contract Box Delivery Routes: Mailbox Improvement Week, May 21–26	5
National Dog Bite Prevention Week, May 20–26, 2001	18
Domestic Mail	
DMM Revision: Labeling List Changes	19
DMM Revision: Parcel Post ZIP Code Deletions	20
Revised Publication: Publication 91, <i>Confirmation Services Technical Guide</i>	20
DMM Revision: Nonmachinable Surcharge for Parcel Post Parcels	21
Special Services Barcoded Label Deadline — Internal Revenue Service Exception	22
APO/FPO Changes	22
Fraud Alert	
Withholding of Mail Orders	22
Invalid Express Mail Corporate Account Numbers	23
Missing, Lost, or Stolen U.S. Money Order Forms	26
Missing, Lost, or Stolen Canadian Money Order Forms	30
Counterfeit Canadian Money Order Forms	32
800 Number Available to Verify Canadian Money Orders	32
International Mail	
IMM Revision: International Mail — International Customized Mail Service	33
IMM Revision: International Mail — Mailing to Belarus	33
IMM Revision: International Mail — Mailing to Brazil	34
IMM Revision: International Mail — Mailing to Croatia	34
IMM and Publication 51 Revisions: International Mail — Mailing Insured Parcels to India	35
IMM and Publication 51 Revisions: International Mail — Mailing to Macedonia (Republic of)	36
Philately	
Pictorial Cancellation: <i>Peanuts</i> Station Pictorial Cancellation (for Second Day Events)	37
Pictorial Cancellations Announcement	41
Special Cancellation Die Hubs	49

Post Offices	
Post Office Changes	50
Postal Employees	
Postmasters/Installation Heads at Level 20–26 Post Offices: Conducting Annual Safety and Health Inspections	51
Safety Alert — Equipment Repair and Replacement	52
Purchasing and Materials	
Correction: FEDSTRIP Address Activity Code Assignment and Maintenance	59
Retail	
What's in Store	60
Vending Servicing Employees: FIRSTCLASS PHONECARD® — New Vending-Exclusive Phone Card	66
Memorial Day Poster	69
<i>Postal Bulletin</i> Distribution	72

Postal Bulletin Index

2000 Annual Index PB 22042 (1-25-01)

Ordering Information: Following is the list of postal stock numbers (PSNs) to use when ordering copies of the *Postal Bulletin* from the MDC:

PB 22049: 7690-04-000-5656	PB 22034: 7690-04-000-5641
PB 22048: 7690-04-000-5655	PB 22033: 7690-04-000-5640
PB 22047: 7690-04-000-5654	PB 22032: 7690-04-000-5639
PB 22046: 7690-04-000-5653	PB 22031: 7690-04-000-5638
PB 22045: 7690-04-000-5652	PB 22030: 7690-04-000-5637
PB 22044: 7690-04-000-5651	PB 22029: 7690-04-000-5636
PB 22043: 7690-04-000-5650	PB 22028: 7690-04-000-5635
PB 22042: 7690-04-000-5649	PB 22027: 7690-04-000-5634
PB 22041: 7690-04-000-5648	PB 22026: 7690-04-000-5633
PB 22040: 7690-04-000-5647	PB 22025: 7690-04-000-5632
PB 22039: 7690-04-000-5646	PB 22024: 7690-04-000-5631
PB 22038: 7690-04-000-5645	PB 22023: 7690-04-000-5630
PB 22037: 7690-04-000-5644	PB 22022: 7690-04-000-5629
PB 22036: 7690-04-000-5643	PB 22021: 7690-04-000-5628
PB 22035: 7690-04-000-5642	

The *Postal Bulletin* is published biweekly; information is effective for one year unless it changes a permanent directive or unless otherwise specified.



Administrative Services

HANDBOOK REVISION

AS-551, Clean Air Act Compliance Guide

Effective May 3, 2001, Handbook AS-551, *Clean Air Act Compliance Guide*, is revised to reflect changes to staff program management responsibilities, clean fuel fleet requirements applicability, reformulated fuel requirements applicability, and Title V permit requirements for stationary emissions sources.

We will incorporate these revisions into the next printed version of Handbook AS-551 and into the online version, located on the corporate intranet at <http://blue.usps.gov/environmental/>; click on *Policy Documents*, then *Handbooks and Reference Material*.

Handbook AS-551, Clean Air Act Compliance Guide

	*	*	*	*	*
1	Introduction				
	*	*	*	*	*
1-5	General Responsibilities				
	*	*	*	*	*

Exhibit 1-5a Organizational Chart of Postal Service Staff Responsible for the CAA Program

[Revise rightmost block, in second row from top, titled "Inspection Service", to read "Office of Inspector General".]

Exhibit 1-5b Postal Service Staff Responsibilities for CAA Compliance

[Revise seventh row under the Headquarters section to read as follows:]

Role	Responsibility
Headquarters	
Office of Inspector General	Conducts audits and surveys to ensure that postal facilities, operations, and programs comply with environmental requirements.

	*	*	*	*	*
1.5-1	Headquarters				
	*	*	*	*	*

[Revise the heading and text titled "Inspection Service" to read as follows:]

Office of Inspector General

The Office of Inspector General is responsible for conducting audits and surveys to ensure that postal facilities, operations, and programs comply with CAA requirements.

	*	*	*	*	*
2	Postal Operations				
	*	*	*	*	*
2-3	Vehicle Fleet				
	*	*	*	*	*

2-3.2 Clean Fuel Fleet Requirements

[Revise the number "16" in the sentence "Note, however, ..." to read "18".]

	*	*	*	*	*
--	---	---	---	---	---

Exhibit 2-3.2a Nonattainment Areas That Must Begin Fleet Clean Fuel Vehicle Purchasing by 1998

[Revise the second sentence in the first row to read as follows:]

However, only four (shown with an asterisk) have not opted out in favor of other methods.

[Delete the asterisks after Baton Rouge, Louisiana, and Washington, DC.]

	*	*	*	*	*
--	---	---	---	---	---

Clean Fuel Credits Program for Fleets

	*	*	*	*	*
--	---	---	---	---	---

[Revise the word "six" in the second paragraph to read "four".]

	*	*	*	*	*
--	---	---	---	---	---

2-3.3 Reformulated Fuels

Reformulated Gasoline Requirement

[Revise the second sentence to read as follows:]

This "oxygenated" fuel is currently being sold as gasoline containing a percentage of ethanol or other approved additives, and will not jeopardize vehicle warranties.

Exhibit 2-3.3**Areas That Must Have Reformulated Gasoline With a 2-Percent Oxygen Content**

[Add the words "and Sacramento" after "San Diego" in the last row.]

	*	*	*	*	*
3	Postal Facilities				
	*	*	*	*	*
3-2	Stationary Sources				
	*	*	*	*	*

3-2.2 Permits

[Revise the second sentence to read as follows:]

Permits are only required for facilities that either emit, or have the potential to emit, pollutants exceeding certain threshold levels, depending on the*** [remainder of text is unchanged].

* * * * *

— Engineering,
Environmental Management Policy, 5-3-01

CORRECTION**PS Form 153, Signature Confirmation**

In *Postal Bulletin* 22047 (4-5-01, page 4), the "Oldest Useable Date" for PS Form 153 was listed as 02/01. The correct date is 10/00.

— Online Services,
Public Affairs and Communications, 5-3-01

Customer Relations

Mail Alert

The mailings below will be deposited in the near future. Offices should honor the requested home delivery dates. Mailers wishing to participate in these alerts, for mailings of 1 million pieces or more, should contact Business Service Network Operations at 800-419-2769 at least one month preceding the requested delivery dates. The Postal

Service also offers electronic Mail Alerts via ADVANCE. For more information, see the *ADVANCE Notification & Tracking System Technical Guide* on the Internet at <http://www.ribbs.usps.gov/files/advance/ADVTECH.PDF> or contact the National Customer Support Center at 800-458-3181.

Title of Mailing	Class and Type of Mail	Requested Delivery Dates	Number of Pieces (Millions)	Distribution	Presort Level	Comments
JC Penney Mothers Day Appreciation	Standard/Letter	5/7–5/9	12.0	Nationwide	CarRt	Harte-Hanks
JC Penney Summer Home Sale	Standard/Flat	5/12–5/17	11.0	Nationwide	CarRt	RR Donnelley
JC Penney Summer Sale	Standard/Flat	5/5–5/10	8.9	Nationwide	CarRt	RR Donnelley
JC Penney Summer Sale	Standard/Postcard	5/14–5/16	12.0	Nationwide	CarRt	Harte-Hanks

— Business Service Network Operations, Sales, 5-3-01

ALL OFFICES WITH CITY MOTORIZED, RURAL, AND HIGHWAY CONTRACT BOX DELIVERY ROUTES

Mailbox Improvement Week, May 21–26

Each year, the Postal Service designates the third full week of May to encourage customers on city motorized, rural, or highway contract box delivery routes to examine and, where necessary, improve the appearance of their mailboxes. Neat, attractive mailboxes make a significant contribution to the appearance of the countryside and to streets in suburban areas. Mailbox Improvement Week, May 21–26, calls attention to the need for providing mailboxes that are:

1. Approved by the Postmaster General.
2. Designed to protect the mail from weather.
3. Safe to use.
4. Conveniently located.
5. Neat in appearance.

Mailboxes that meet these five important requirements help delivery and collection operations and improve service to the entire route. There are two approved styles of curbside mailboxes: (1) traditional design, in three standard sizes (see Exhibit A); and (2) contemporary design, also in three sizes (see Exhibit B). USPS Std 7 governs the design and specifications of curbside mailboxes and includes provisions for improved quality of the product and a new category, locked mailboxes.

Notice 209

Postmasters should send Notice 209, *Mailbox Improvement Week*, to all rural and highway contract box delivery route customers the week before Mailbox Improvement Week to alert them of the event. Notice 209 can be requisitioned from the Material Distribution Center (MDC) as follows:

- Use Touch Tone Order Entry by calling 1-800-332-0317, option 1, then option 2.
- Send an F3Fill-completed PS Form 7380, *MDC Supply Requisition*, by cc:Mail to MDC Customer Service at TOKS001L.
- Mail a completed PS Form 7380 to the following address:

SUPPLY REQUISITIONS
 500 SW GARY ORMSBY DR
 TOPEKA KS 66624-9702

Exhibit A

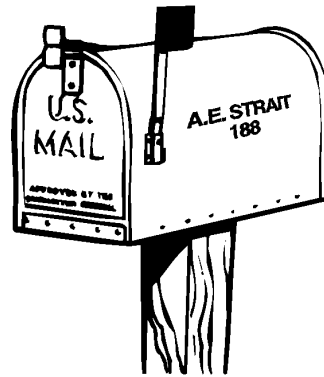

Exhibit B

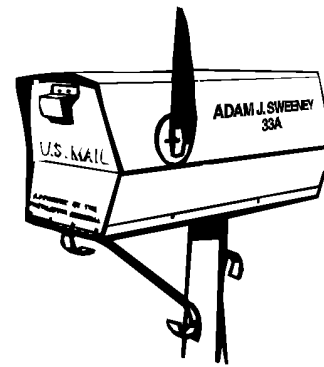
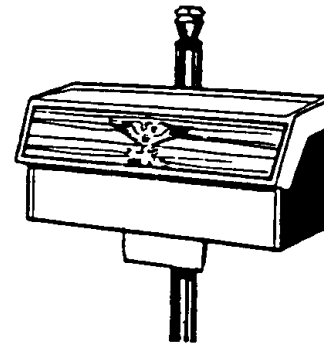

Exhibit C



The relevant ordering information for Notice 209 is as follows:

PSN: 7610-03-000-9145
 PSIN: NOT209
 Unit of Issue: EA
 Quick Pick #: 496
 Bulk Pack Quantity: N/A
 Price: \$.0242
 Edition Date: November 2000

City Motorized, Rural, and Highway Contract Box Delivery Routes

Customers must use *only* approved traditional or contemporary curbside mailboxes for new installations or replacements. However, a customer may use a custom-built curbside mailbox if the local postmaster gives prior approval and the mailbox conforms generally to the same requirements as approved manufactured curbside mailboxes relative to the flag, size, strength, and quality of construction. Carriers on motorized city routes may continue to serve mailboxes that are designed primarily for use by customers receiving door delivery and that have been erected and served under previous regulations (see Exhibit C on page 5). However, carriers should advise customers that they may use only approved curbside mailboxes when replacing these types of mailboxes. A list of approved manufacturers of traditional curbside mailboxes appears on pages 11–12.

For motorized city routes, and where the use of street names and house numbers is authorized on rural and highway contract box delivery routes, the mailbox must display the number on the side of single mailboxes or on the door of grouped mailboxes. If the mailbox is on a street other than the one on which the customer resides, the street name and house number must be on the mailbox. When rural and highway contract box delivery route customers have assigned box numbers, the numbers must appear on the side of single mailboxes or on the doors of grouped mailboxes, visible to the approaching carrier. The street number, box number, and/or any other address information must be inscribed in contrasting color in neat letters and numerals not less than 1 inch in height. In all instances, placing the owner's name on the box is optional.

Motorized city, rural, and highway contract box delivery route customers should be encouraged but not required to group mailboxes whenever practical, especially where many mailboxes are located at or near crossroads, service turnouts, or similar locations. Customers should also paint mailboxes and supports/posts and keep them rust-free. Advertising on mailboxes and supports/posts is prohibited.

In areas where snow removal is a problem, the Postal Service suggests using a semi-arch or extended arm-type

support (see Exhibit D), which allows snowplows to sweep near or under mailboxes without damaging supports and provides easy access to the mailboxes by carriers and customers.

Exhibit D

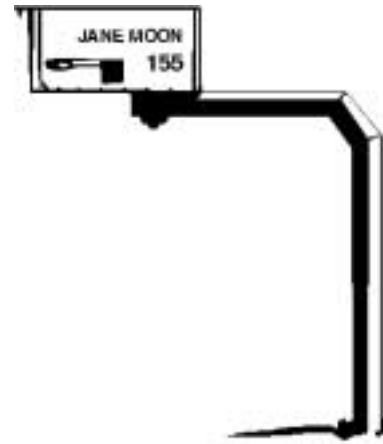

Generally, mailboxes are installed at a height of 3.5–4.0 feet from the road surface to the bottom of the mailbox or point of mail entry. Mailboxes are set back 6–8 inches from the front face of the curb or road edge to the mailbox door. However, because of varying road and curb conditions and other factors, the Postal Service recommends that customers contact the postmaster or carrier before erecting or replacing mailboxes and supports.

Location

Customers must place mailboxes on motorized city, rural, and highway contract box delivery routes so a carrier can safely and conveniently serve them without leaving his or her vehicle. The mailboxes must be on the right-hand side of the road in the carrier's travel direction in all cases where traffic conditions make it dangerous for the carrier to drive to the left to reach the mailboxes, or where doing so would constitute a violation of traffic laws and regulations (*Postal Operations Manual (POM) 632.6* exempts apartment houses and other multiple dwellings from this rule). On new rural and highway contract box delivery routes, all mailboxes must be on the right-hand side of the road in the direction of the route line of travel. Mailbox placement must conform with state laws and highway regulations. City motorized, rural, and highway contract box delivery route carriers are subject to the same traffic laws and regulations as other motorists. Customers must remove obstructions, including vehicles, trash cans, and snow, that impede efficient delivery. Except when a mailbox is temporarily blocked, carriers must have access to the mailbox without leaving the vehicle unless authorized to dismount.

Mailbox Supports

The Postal Service does not regulate mailbox supports in any way except for purposes of carrier safety and delivery efficiency. Posts and other supports for curbside mailboxes are owned and controlled by customers, who are responsible for ensuring that posts are neat and adequate in strength and size. Heavy metal posts, concrete posts, and miscellaneous items of farm equipment, such as milk cans filled with concrete, are examples of potentially dangerous supports. The ideal support is an assembly that bends or falls away when struck by a vehicle. Post or support designs may not represent effigies or caricatures that disparage or ridicule any person. Customers may attach the box to a fixed or movable arm. POM 632.5 specifies postal regulations regarding construction and placement of mailboxes and supports on motorized city, rural, and highway contract box delivery routes.

The Federal Highway Administration (FHWA) has determined that mailbox supports no larger than 4 inches by 4 inches, or a 2-inch diameter standard steel or aluminum pipe, buried no more than 24 inches, should safely break away if struck by a vehicle. According to FHWA, the mailbox must also be securely attached to its post to prevent separation if struck. See Exhibits E (page 13) and F (page 14) for examples of mailbox mountings and supports suggested by the FHWA.

Cluster Box Units and All-Weather Parcel Lockers

During Mailbox Improvement Week, postmasters and managers or their designees must review all cluster box units (CBUs), neighborhood delivery and collection box units (NDCBUs), and all-weather parcel lockers in their delivery areas to identify any hazards or irregularities, and they must record the results of the review. PS Form 8143, *Equipment Checklist and Followup Review*, is the suggested format to use in conducting and recording the reviews. PS Form 8143 is available only in this *Postal Bulletin* (see Exhibit G on page 15) and must be reproduced locally. Employees conducting the reviews must complete PS Form 1624, *Delivery/Collection Equipment Work Request*, for any equipment that poses a safety hazard to postal customers or employees. Requisition PS Form 1624 from the MDC using normal ordering procedures (described previously). The relevant ordering information for PS Form 1624 is as follows:

PSN: 7530-01-000-9392
 PSIN: PS1624
 Unit of Issue: SE
 Quick Pick #: N/A
 Bulk Pack Quantity: N/A
 Price: \$.0411
 Edition Date: July 1992

Equipment Review Procedure

Employees must use the CBU and parcel locker equipment checklist and follow-up review procedure when examining the condition of CBUs, NDCBUs, and parcel lockers. You must:

1. List the unit location, type, and manufacturer in the left-hand column. If you are able to access the back of the unit, list the unit's serial number.
2. Assign each checklist item one of the following ratings:
 - a. OK — Equipment does not need attention for this item.
 - b. X — Equipment needs attention for this item.
 - c. NA — Item does not apply to this particular piece of equipment.
3. When examining the equipment, use the instructions below to complete PS Form 8143:
 - a. Check equipment. It should be straight, vertical, and firmly mounted with the customer compartments facing away from the street. Attempt to shake the unit; it should hardly move. If equipment is not firmly mounted, note whether it is the connection at ground level that is loose or the connection between the pedestal and customer compartments that needs attention.
 - b. Check visible welds. Make note of cracked, broken, or rusted welds. For NDCBUs and outdoor parcel lockers (OPLs) only, tap the pedestal with a lightweight hammer, especially along the seams, to check for corrosion from the inside out or perforated corrosion.
 - c. Observe whether the carrier access door is locked and secure. Open it and observe whether it is bowed or warped and whether the door and locking bar operate smoothly. With the carrier access door open, check whether restraining devices prevent the door from blowing closed. These devices, which may have to be set manually, should be serviceable.
 - d. Ensure that the arrow lock operates smoothly and that the mounting screws are tight. For NDCBUs and OPLs, the cover that protects the arrow lock from customer tampering must be serviceable and firmly attached.
 - e. Ensure that all customer access doors are present, closed, and locked with no visible damage or signs of forced entry. Check that customer door numbers are readable.
 - f. Ensure that the exterior surface of the unit is free from rust and graffiti.

- g. Examine the unit. Check it for defects or damage and whether it reflects a proper Postal Service image.
 - h. Check whether the unit and/or any protecting structure appears watertight and in good repair. Check whether there are any noticeable watermarks inside the unit or any wet mail.
 - i. Note any other conditions that require attention. Also, look for signs of vandalism such as pry marks on doors and locks.
4. Record the results of the inspection on the checklist.
 5. Submit the completed PS Form 1624 for each unit reviewed to the maintenance office responsible for CBU installation and/or repair in the area.

Carriers must note equipment deficiencies and report them to the postmaster, supervisor, or designee. The postmaster or designee must then submit PS Form 1624 reporting the equipment defects. In addition, carriers should complete PS Form 1767, *Report of Hazard, Unsafe Condition, or Practice*, for items that pose an immediate threat to safety, such as an improperly secured or leaning CBU. PS Form 1767 should be ordered from the MDC using normal ordering procedures. The relevant ordering information for PS Form 1767 is as follows:

PSN: 7530-01-000-9422
 PSIN: PS1767
 Unit of Issue: SE
 Quick Pick #: 141
 Bulk Pack Quantity: N/A
 Price: \$.0625
 Edition Date: December 1982

The postmaster or supervisor must immediately notify by telephone the office responsible for repair of reported hazards. The postmaster or supervisor must follow up to ensure that the work is satisfactorily completed and documented. The office responsible for repair should use its local buying authority to accomplish the repairs.

Effective April 2000, the following are approved manufacturers of centralized delivery equipment. This list supercedes all previously published lists of approved manufacturers.

Approved Manufacturers Cluster Box Units (CBUs)

USPS-B-1118F, April 2001

AMERICAN LOCKER GROUP INC
 608 ALLEN ST
 JAMESTOWN NY 14701-3966
 800-828-9118
 716-664-9600
 716-483-2822 (fax)
 Contract #072368-01-P-0378
Unit is painted plastic — pedestal is painted plastic.

USPS-B-1118F, April 2001

AUTH-FLORENCE MANUFACTURING CO
 591 MITCHELL RD
 GLENDALE HEIGHTS IL 60139-2582

800-275-1747
 630-545-1784
 630-545-1896 (fax)
 Contract #072368-01-P-0379
Unit is anodized, painted aluminum — pedestal is anodized, painted aluminum.

SECURITY MANUFACTURING CORP
 815 SOUTH MAIN ST
 GRAPEVINE TX 76051-5535

800-762-6937
 817-329-1600
 817-481-3993 (fax)
 Contract #072368-01-P-0380
Unit is anodized, painted aluminum — pedestal is anodized, painted aluminum.

Outdoor Parcel Locker (OPL)

USPS-B-1116A, September 13, 1989

Unit is anodized aluminum — pedestal is anodized aluminum.

AMERICAN LOCKER GROUP INC
 608 ALLEN ST
 JAMESTOWN NY 14701-3966

800-828-9118
 716-664-9600
 716-483-2822 (fax)
 Contract #072368-01-P-8378
Unit is plastic — pedestal is anodized aluminum. (Note: Pedestal can only be used on American Locker units.)

Replacement Pedestals — NDCBU Universal

Can be used on all manufacturers' units.

AUTH-FLORENCE MANUFACTURING CO
 591 MITCHELL RD
 GLENDALE HEIGHTS IL 60139-2582

800-275-1747
 630-545-1784
 630-545-1896 (fax)
 Contract #072368-01-P-0379
Pedestal is anodized aluminum.

PAGE SPECIALTY COMPANY
 5877 S FULTON WAY
 ENGLEWOOD CO 80111-3719

Contact: Bob Page
 800-327-7439
 303-770-2842
 303-771-6837 (fax)
 No national contract.
Pedestal is painted aluminum. (Note: Page is a small business.)

SECURITY MANUFACTURING CORP
815 SOUTH MAIN ST
GRAPEVINE TX 76051-5535

800-762-6937
817-329-1600
817-481-3993 (fax)

Pedestal is painted aluminum. (Note: Security is a woman-owned business.)

GREG'S BODY & FABRICATING
PO BOX 813
FRUITLAND PARK FL 34731-0813

Contact: Hansdel Gregory Swanson
352-787-6262
352-787-6262 (fax)

No national contract.

Pedestal is painted aluminum. (Note: Greg's is a small business.)

Replacement Pedestals — OPL

AMERICAN LOCKER GROUP INC
608 ALLEN ST
JAMESTOWN NY 14701-3966

800-828-9118
716-664-9600
716-483-2822 (fax)

Contract #072368-01-P-0372

Pedestal is anodized aluminum. (Note: Can only be used on American Locker units.)

Replacement Pedestals — Carousel/Rotating

PAGE SPECIALTY COMPANY
5877 SOUTH FULTON WAY
ENGLEWOOD CO 80111-3719

Contact: Bob Page
800-327-7439
303-770-2842
303-771-6837 (fax)

No national contract.

Pedestal is painted steel. (Note: Page is a small business.)

Apartment House Mail Receptacles — Horizontal and Vertical

USPS Publication 17, April 1982

USPS-STD-4B(RDD), Effective May 1, 1975

AMERICAN DEVICE MANUFACTURING
591 MITCHELL RD
GLENDALE HEIGHTS IL 60139-2582

800-275-1747
630-545-1784
630-545-1896 (fax)

AUTH-FLORENCE MANUFACTURING CO
591 MITCHELL RD
GLENDALE HEIGHTS IL 60139-2582

800-275-1747
630-545-1784
630-545-1896 (fax)

BOMMER INDUSTRIES INC
PO BOX 187
LANDRUM SC 29356-0187

800-334-1654
864-457-3301
864-457-5370 (fax)

JENSEN INDUSTRIES INC
1946 E 46TH ST
LOS ANGELES CA 90058-2096

323-235-6800
800-882-6489 (fax)

SALSBURY INDUSTRIES
1010 E 62ND ST
LOS ANGELES CA 90001-1598

800-323-3003
213-232-6181
800-725-9393 (fax)

SECURITY MANUFACTURING CORP
815 S MAIN ST
GRAPEVINE TX 76051-5535

800-762-6937
817-329-1600
817-481-3993 (fax)

AMERICAN EAGLE MANUFACTURING CO
3017 WHEELLOCK ST
DALLAS TX 75220-2944

214-358-5544
214-358-3066 (fax)
Horizontal only.

MAIL SECURITY
714 W FLORENCE AVE
LOS ANGELES CA 90044-6106

213-750-7844
213-750-3433 (fax)
Vertical only.

THE SALVATION ARMY
ECONOMIC RECOVERY PROGRAM
5600 RICKENBACKER RD
BELL CA 90201-6418

213-263-1206
213-626-4786
213-263-8543 (fax)

Rear loading 35 compartment 5x7 only; manufacturer's product #9274111-4.

Locks & Cams, CBU/NDCBU

PSIN 0910A and B (locks) & PSIN 0913A through
K (cams)
USPS-L-1172B, March 2, 1992

ESP LOCK PRODUCTS INC
375 HARVARD ST
LEOMINSTER MA 01453-3499

Contact: Sari Phibault
978-537-6121
978-537-1699 (fax)
No national contract.

HUDSON LOCK INC
81 APSLEY ST
HUDSON MA 01749-1547

Contact: Joanna Smith
978-562-3481
978-562-9859 (fax)
No national contract.

HURD CORPORATION
503 BOHANNON AVE
PO BOX 145
GREENEVILLE TN 37744-1450

423-787-8800
423-787-8817 (fax)
No national contract.

NATIONAL CABINET LOCK
200 OLD MILL RD
PO BOX 200
MAULDIN SC 29662-0200

Contact: Teresa Gilstrap
803-297-6655
803-297-9987 (fax)
Contract #266351-98-B-0553 and #266351-98-B-0933

WIND CORPORATION
14 FINANCE DR
DANBURY CT 06810-4132

Contact: Patrick Wind
203-778-1001
203-778-1006 (fax)
Contract #266351-99-B-0987

**Locks, Interlocking System, Parcel Locker,
PSIN 0306P**

USPS-L-1294A, November 19, 1996

ILCO UNICAN CORPORATION
400 JEFFREYS RD
PO BOX 2627
ROCKY MOUNT NC 27802-2627

Contact: Don Herman (x256)
800-334-1381
252-446-3321
252-446-4702 (fax)
No national contract.

AMERICAN LOCKER GROUP INC
608 ALLEN ST
JAMESTOWN NY 14701-3966

Contact: Jim Lange
800-828-9118
716-664-9600
716-483-2822 (fax)
No national contract.

Note: Apartment-style boxes are approved for installation; however, the Postal Service is prohibited from purchasing this equipment. You may order replacement parts for postal-owned equipment that was installed in the past.

State and Local Regulations

Some states have enacted laws that are more stringent and specific about the type of mailbox that may be used, the post or support that must be used to mount the mailbox, and the location of the delivery equipment. Regulations and recommendations published in this notice might not reflect appropriate requirements for your area. When providing guidance to the general public concerning mailbox placement and replacement, advise them not only of postal regulations but also of any mailbox regulations that you know have been enacted by state or local authorities.

Publicity

Postmasters should give these guidelines and suggestions maximum local publicity. Consult your area Public Affairs and Communications representative for further guidance and assistance in publicizing Mailbox Improvement Week. The news release on page 17 is provided for postmasters to distribute to daily or weekly newspapers or broadcast stations in their delivery area to promote Mailbox Improvement Week. Postmasters should retype the release double-spaced on Postal Service letterhead. It may also be helpful to alert the media to locations of particularly interesting mailboxes in your delivery area.

Responsibility

Motorized city, rural, and highway contract box delivery route carriers must cooperate to ensure the success of this endeavor and later report the results to the postmaster. Also, postmasters should use the most up-to-date list of approved manufacturers and mailbox suppliers when providing motorized city, rural, and highway contract box delivery route customers with information about the type of box to install.

— *Delivery Policies and Programs,*
Delivery, 5-3-01



Curbside Mailboxes Approved By The Postmaster General

The following list of curbside mailboxes approved by the Postmaster General supersedes all previously published lists of approved manufacturers.

Manufacturers and Models

ARMADILLO ENCLOSURES INC
PO BOX 462199
ESCONDIDO CA 92046-2199
1000F [T2]
1000R [T2]

AMERICAN MAILBOX CORP
35 CENTURY TRL
HARRISON NY 10528-1717
LARGE DOMED ROOF [C2]

ARMOR PLATE MAILBOX INC
PO BOX 1060
STERLING HEIGHTS MI 48311-1060
MB-001-COLOR [C2]

BACOVA GUILD LTD
1 MAIN ST GENERAL DELIVERY
BACOVA VA 24122-9999
#122 [T1]
#128 [T2]
#121 [T3]

BERARDI AND COMPANY
15745 CRABBS BRANCH WAY
ROCKVILLE MD 20855-2634
DESIGNER 474 [C1]

BERKELEY PRODUCTS INC
14680 ALONDRA BLVD
LA MIRADA CA 90638-5603
M1000 (ALUMINUM) [N/A]
M1000AG (ALUMINUM) [N/A]
M1000AR (ALUMINUM) [N/A]
M4000 (ALUMINUM) [C1]
M4000P (ALUMINUM) [C1]
M5000 (ALUMINUM) [C1]

BRANDON INDUSTRIES INC
1601 W WILMETH RD
MCKINNEY TX 75069-8250
M1 [C2]
M2 [C2]

CARMEL WOOD PRODUCTS
24723 UPPER TRL
CARMEL CA 93923-8343
C1 [C1]

CLAPPER SUPPLY
320 E LYNN CREEK DR
ARLINGTON TX 76002-5455
SECURED MAILBOX [N/A]

CUTLER MANUFACTURING CORP
3240 FLIGHTLINE DR
LAKELAND FL 33811-2844
MAILMASTER [N/A]
1012M [N/A]
1013M [N/A]

FLAMBEAU AIRMOLD CORP
PO BOX 610
ROANOKE RAPIDS NC 27870-0610
POST MAX [C1]

FLAMBEAU PRODUCTS CORP
15981 VALPLAST RD
PO BOX 97
MIDDLEFIELD OH 44062-0097
6529 [C1]
6530 [C1]
6531 [C1]

FULTON CORP
303 EIGHTH AVE
FULTON IL 61252-1632
T1 [T1]
T2 [T2]
T3 [T3]

GDM COMPANY
1316 1/2 CLEVELAND RD
SANDUSKY OH 44870-4213
HB1 [C1]
HB2 [C2]
HT2 [C2]
HB3 [C3]

GER-IVA BERRY COMPANY
1400 INDUSTRIAL AVE
HIAWATHA IA 52233-1159
SECURE MAILBOX [N/A]

HOME IMPRESSIONS
1923 TATE BLVD SE
HICKORY NC 28602-1430
POSTMASTER [C1]
MB-700 [C2]

IMPERIAL MAIL BOX SYSTEMS INC
3901 NORRIS DR
MILLBROOK AL 36054-2433
STYLE 001 [C2]

JANZER CORP
9 CHELTEN WAY
TRENTON NJ 08638-5000
STONE BRAE [C2]

J & J MAILBOX
20594 OTTAWA RD
APPLE VALLEY CA 92308-6253
LETTER LOCKER [N/A]

JAMESTOWN ADVANCED PRODUCTS INC
2855 GIRTS RD
JAMESTOWN NY 14701-9666
23 [C1]
27 [C1]
29 [C2]
44 [C1]
49 [C1]
54 [C2]
56 [C2]
86 [C2]

MAIL SYSTEMS NW INC
12365 SW TOOZE RD
SHERWOOD OR 97140-7205
SENATOR [N/A]
BEL AIRE [N/A]
BEL AIRE REAR DOOR [N/A]

MB CLASSICS
909 CENTENNIAL RD
NARBETH PA 19072-1407
CONTEMPORARY STYLE [C1]

MCDOWELL FABRICATIONS INC
PO BOX 411
MUSTANG OK 73064-0411
SAFETMAIL

MR TWO-DOOR MAILBOX INC
9750 PAGE RD
STREETSBORO OH 44241-5014
TWO DOOR [C2]
BOXGLOW [C2]

NORTHWEST METAL PRODUCTS
PO BOX 10
KENT WA 98035-0010
TRADITIONAL #1 [T1]

RUBBERMAID
1147 AKRON RD
WOOSTER OH 44691-6000
7271 ECONO MAILBOX [C1]
7272 SMALL [C1]
7273 LARGE [C2]
7276 [C1]

SHELLTER INC
PO BOX 30011
INDIANAPOLIS IN 46230-0011
RURAL MAILBOX SIZE 1 [C1]

THE SOLAR GROUP
PO BOX 525
TAYLORSVILLE MS 39168-0525
CC-1R (USES ST-10) [C1]
CC-2R (USES ST-10) [C1]
CENTURY 2000 [C2]
PL-10 [C1]
RB-15 [C2]
ST-10 ALUMINUM [T1]
ST-10 [T1]
ST-15 [T2]
ST-20 [T3]
BB2D [C2]
LP-12 [C1]

SPECIAL LITE PRODUCTS
COMPANY INC
434 LATROBE DERRY RD
LOYALHANNA PA 15661-9713
SCF-1003 [C1]

STEEL CITY CORP
190 N MERIDIAN RD
YOUNGSTOWN OH 44501-1227
CA-1B CARLYLE [C1]
LE-1B BRUTE [C1]
PX-1 POLYBOX [C1]
1-1 [T1]
1-1 1/2 [T2]
2-2 [T3]
315B STREAMLINER [C1]
2D-1 TWO DOOR BRUTE [C1]

STEP 2 CORP
10010 AURORA HUDSON RD
STREETSBORO OH 44241-1621
5401 [C1]
5402 [C1]
5403 [C2]

THREE 60 CORP
10823 PLAZA DR
WHITMORE LAKE MI 48189-9737
CLASSIC COMBO [C1]

VEEDERS MAILBOX INC
8920 GLENDALE MILFORD RD
LOVELAND OH 45140-8908
SMVMB-W & SMVMB-B [C1]
LGVMB-W & LGVMB-B [C2]
SMVMB-G & SMVMB-T [C1]
LGVMB-G & LGVMB-T [C2]
SMVMB-SS [C1]
LGVMB-SS [C2]

VIRCO ASSOCIATES INC
145 BREA CANYON RD
WALNUT CA 91789-3029
67-0993 (ALUMINUM)

ZUBIEL RF SYSTEMS INC.
PO BOX 1184
MONUMENT CO 80132-1184
201, MAILCALL [C1]

**Exhibit E
Cantilever Mailbox Supports**

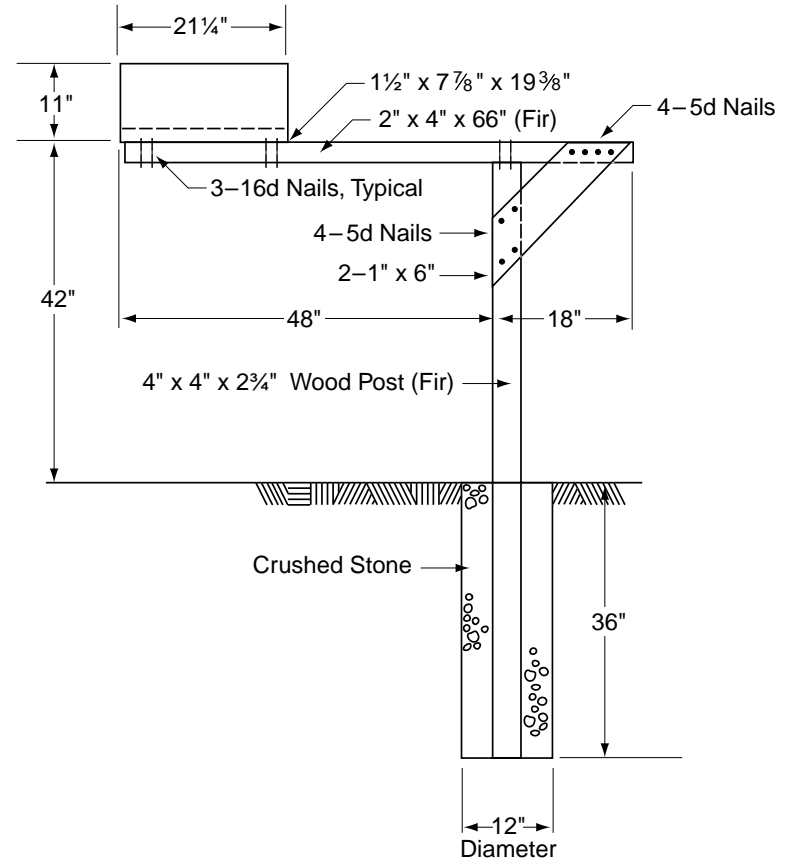
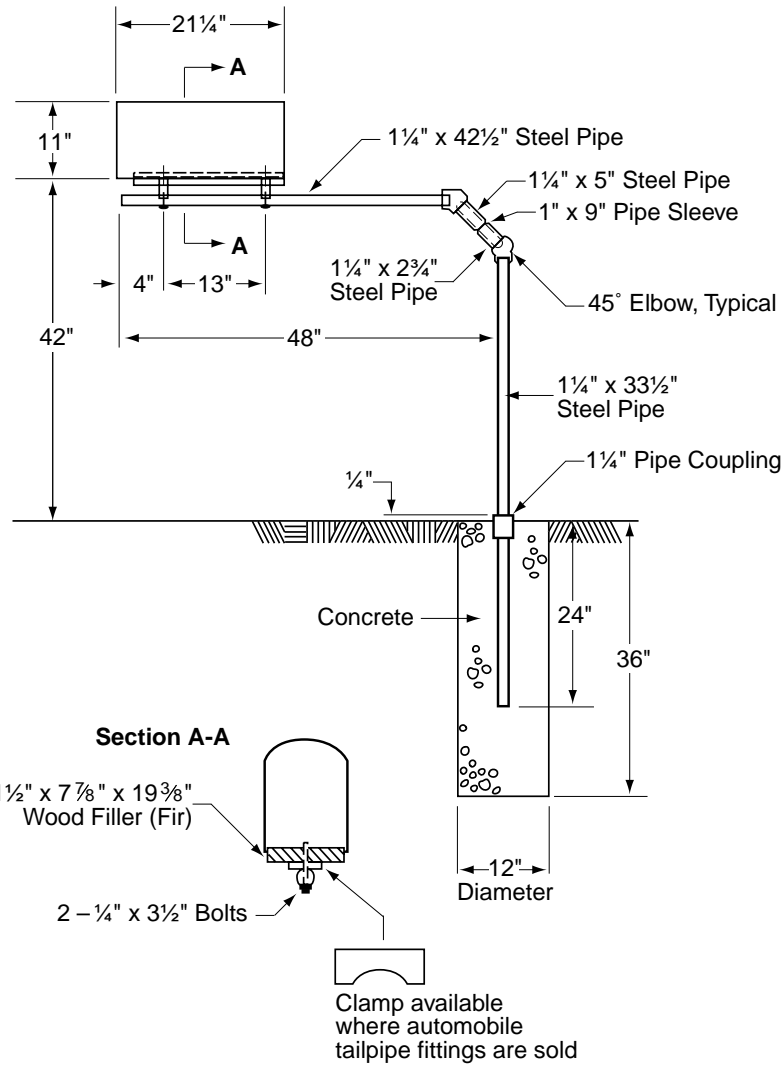
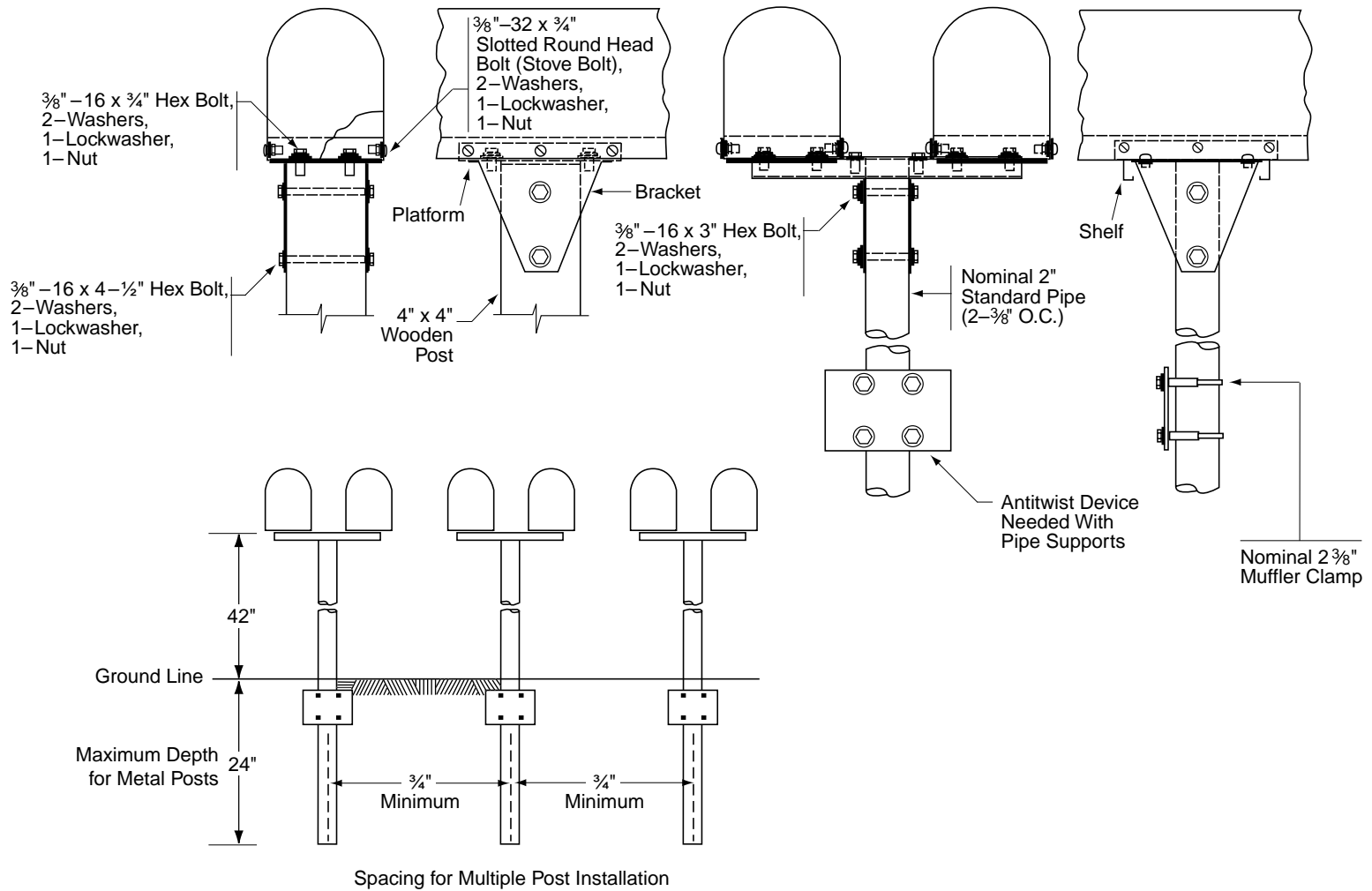

Exhibit F
Single and Double Mailbox Installations



This page intentionally left blank



POSTAL NEWS

FOR IMMEDIATE RELEASE
[INSERT DATE]

Contact: [INSERT YOUR NAME]
[INSERT YOUR PHONE NUMBER]
Internet: www.usps.com

Mailbox Improvement Week Arrives in Time for Spring Cleaning

The U.S. Postal Service is asking all [city name] homeowners to inspect and repair their mailboxes during Mailbox Improvement Week, May 21–26, says Postmaster [full name].

“Repairing suburban and rural mailboxes improves the appearance of our community and makes delivering and receiving mail safer for our carriers and customers,” [last name] says.

The Postal Service makes this annual request because of the wear and tear that occurs to mailboxes every year. “This is especially important after the effects of last winter,” [he/she] adds [if applicable].

Some of the typical activities that may need to be done include:

- Replacing loose hinges on a mailbox door.
- Repainting a mailbox that may have rusted or started peeling.
- Remounting a mailbox post if loosened.
- Replacing or adding house numbers.

“If a homeowner plans to install a new mailbox or replace a worn one, he or she must use only Postal Service–approved traditional or contemporary mailboxes,” said [last name]. “Customers should be careful when purchasing curbside mail receptacles because the use of unapproved boxes is prohibited. Customers may use a custom-built mailbox, but they must consult with my office to ensure it conforms to guidelines applying to flag, size, strength, and quality of construction.”

For more information on the use of names or numbers on mailboxes, or answers to any other questions, contact Postmaster [full name] at [phone number] or call your local postmaster at [phone number].

###

National Dog Bite Prevention Week, May 20–26, 2001

In an effort to raise awareness about the devastating effects of dog bites on the health of letter carriers and the public, the U.S. Postal Service has announced its participation in National Dog Bite Prevention Week, May 20–26, 2001.

Millions of Americans share their homes and their hearts with dogs, but an estimated 4.7 million people in the United States are bitten by dogs each year. More than 2 million of these victims are children.

Too often our Postal Service employees encounter unrestrained or stray dogs while on the job during a delivery day. Therefore, it is important that dog owners practice responsible pet ownership — because one dog bite is still one bite too many.

Dog bites to Postal Service employees peaked during the mid-1980s when more than 7,000 letter carriers were attacked. Although it remains a serious health problem, the number of dog bites reported by Postal Service employees since that time has dropped considerably. Through extensive training, public awareness and outreach programs, the number of Postal Service employees reporting dog bites was reduced to 2,721 in 2000.

Listed below are dog bite statistics from fiscal years 1990–2000:

Year	1990	1991	1992	1993	1994	1995	1996	1997	1998	1999	2000
No. of Bites	2,782	2,733	2,802	2,671	2,782	2,851	2,795	2,798	2,541	2,729	2,721



To help continue the recent trend of fewer dog bites, the Postal Service is reminding customers and their family and friends to observe the following simple tips:

To avoid being bitten:

- Don't run past a strange dog. A dog's natural instinct is to chase and catch prey.
- If a dog threatens, don't scream. Avoid eye contact, try to remain motionless until the dog leaves, then back away slowly until the dog is out of sight.
- Don't approach a strange dog, especially one that's tethered or confined.
- Don't pet a dog, even your own, without letting him see and sniff you first.

To be a responsible dog owner:

- When your letter carrier comes to your home, keep your dog inside, away from the door, in another room, or on a leash.
- Don't let your child take mail from the letter carrier in the presence of your dog. Your dog's instinct is to protect the family.
- Obedience training can teach your dog proper behavior and help you control your dog in any situation.
- Spay or neuter your dog — unneutered dogs are more likely to bite!

Additional information on preventing dog bites is available on the Postal Service's Web site at www.usps.com, or visit the Humane Society of the United States' Web site at www.nodogbites.org.

Postal Employees may also refer to Publication 174, *How to Avoid Dog Bites: Dogs and Dog Repellent*, on the corporate intranet at blue.usps.gov (select *Publications*).

— Community Relations, Public Affairs and Communications, 5-3-01

Domestic Mail

DMM REVISION

Labeling List Changes

Effective May 3, 2001, *Domestic Mail Manual* (DMM) L001 is revised to reflect changes in mail processing operations. Although mailers are encouraged to label according to this revised list immediately, they must comply with these changes no later than July 15, 2001.

We will incorporate these changes into the online DMM available via Postal Explorer at <http://pe.usps.gov> on May 3, 2001, and into the printed version of DMM Issue 57.

Domestic Mail Manual (DMM)

* * * * *

L Labeling Lists

L000 General Use

L001 5-Digit Scheme — Periodicals Flats and Irregular Parcels, Standard Mail Flats, and BPM Flats

* * * * *

Column A Destination ZIP Codes	Column B Label Container To
Change From:	
54901-04	OSHKOSH WI 54901
78717, 26, 29, 50	AUSTIN TX 78717
78730, 59	AUSTIN TX 78730
78732, 34	AUSTIN TX 78732
99502, 07, 18	ANCHORAGE AK 99502
Change To:	
54901, 02, 04	OSHKOSH WI 54901
78717, 26, 29	AUSTIN TX 78717
78730, 31	AUSTIN TX 78730
78732, 34, 38	AUSTIN TX 78732
99502, 18	ANCHORAGE AK 99502
Add:	
11352, 55	FLUSHING NY 11355
11359-61	BAYSIDE NY 11360
11365, 66	FRESH MEADOWS NY 11365
11369-71	EAST ELMHURST NY 11369
11373, 80	ELMHURST NY 11373
11375, 76	FOREST HILLS NY 11375
11385, 86	RIDGEWOOD NY 11385
11427-29	QUEENS VILLAGE NY 11427
11431-33	JAMAICA NY 11431
89113, 35	LAS VEGAS NV 89113
Delete:	
02140-42, 63	CAMBRIDGE MA 02140
78705, 51	AUSTIN TX 78705
78727, 58	AUSTIN TX 78727
89103, 13, 35	LAS VEGAS NV 89103
97477, 78	SPRINGFIELD OR 97477

* * * * *

— Logistics,
Network Operations Management, 5-3-01

DMM REVISION

Parcel Post ZIP Code Deletions

Effective April 19, 2001, *Domestic Mail Manual* (DMM) E751 Exhibit 8.0 is revised to delete certain ZIP Codes. The correct facility to qualify for destination delivery unit rate is now consistent with the facility associated with the 5-digit ZIP Code as listed in the AMS Drop Ship Product.

We will include these revisions in the printed version of DMM Issue 57 and in the monthly update of the online DMM available via Postal Explorer at <http://pe.usps.gov>.

Domestic Mail Manual (DMM)

	*	*	*	*	*
E	Eligibility	*	*	*	*
E700	Package Services	*	*	*	*
E750	Destination Entry				
E751	Parcel Select	*	*	*	*

Exhibit E751.8.0 Delivery Facilities Different From Those in the Drop Shipment Product

[Revise Exhibit 751.8.0 by deleting the following entries:]

ZIP Codes Served	Destination Delivery Unit Location
NEW YORK	
10101	Radio City Station, 322 W 52nd Street, New York, NY 10199-9998
10108–10109, 11–12, 29	Times Square Station, 340 W 42nd Street, New York, NY 10036-9998
10113	Old Chelsea Station, 217 W 18th Street, New York, NY 10011-9998
10115	Manhattanville Station, 365 W 125th Street, New York, NY 10027-9998
10159	Madison Square Station, 149 E 23rd Street, New York, NY 10010-9998
10203, 42, 49, 56–61	Church Street Station, 90 Church Street, New York, NY 10007-9998
10268	Wall Street Station, 73 Pine Street, New York, NY 10005-9998
10272, 10292	Peck Slip Station, 1 Peck Slip, New York, NY 10038-9998
10274	Bowling Green Station, 25 Broadway, New York, NY 10004-9998
10276	Cooper Station, 93 Fourth Avenue, New York, NY 10003-9998
10285–86	Church Street Station, 90 Church Street, New York, NY 10007-9998
11355	Flushing Main Office, 4165 Main Street, Flushing, NY 11355-9998
11359, 61	Bayside Annex, 41-29 216th Street, Flushing, NY 11361-9998
11377	Woodside Post Office, 3925 61st Street, Flushing, NY 11377-9998

— Operational Requirements,
Operations Planning and Processing, 5-3-01

REVISED PUBLICATION

Publication 91, Confirmation Services Technical Guide

Publication 91, *Confirmation Services Technical Guide* (formerly *Delivery Confirmation Technical Guide*), is available on both the internal (<http://blue.usps.gov>) and external (<http://www.usps.com>) Postal Service Web sites. The new edition of Publication 91 contains updated information on Delivery and Signature Confirmation services, and the integrated barcode.

The revised printed version of Publication 91 will be ready for order through normal distribution channels in May. Availability will be announced in the *Postal Bulletin*.

— Information Systems,
Expedited/Package Services, 5-3-01

DMM REVISION

Nonmachinable Surcharge for Parcel Post Parcels

Effective May 3, 2001, *Domestic Mail Manual* (DMM) C700.2 is revised by deleting 2e and 2f to clarify that the nonmachinable surcharge does not apply to Parcel Post parcels that contain perishable items (e.g., fruit, plants, nuts, cheese, meat, candy, eggs, trees, and shrubs) as long as the parcel itself meets the criteria for a machinable parcel. The packaging must be sufficient to prevent damage to the contents of the mailpiece, to other parcels, and to postal machinery during machine processing. Perishable items sent via Parcel Post are subject to the nonmachinable surcharge if the parcels do not meet the machinable standards set forth in renumbered DMM C700.2h.

We will incorporate these revisions into the printed version of DMM Issue 57 and into the monthly update of the online DMM available via Postal Explorer at <http://pe.usps.gov>.

- d. A can, roll, or tube, or wooden or metal box.
- e. Books, printed matter, or business forms weighing more than 25 pounds.
- f. A high-density parcel weighing more than 15 pounds and exerting more than 60 pounds per-square-foot pressure on its smallest side.
- g. A film case weighing more than 5 pounds or with strap-type closures, except any film case the USPS authorizes to be entered as a machinable parcel under C050 and to be identified by the words "Machinable in United States Postal Service Equipment" permanently attached as a nontransferable decal in the lower right corner of the case.
- h. Parcels with characteristics (such as inadequate packaging) that could result in damage to the contents of the mailpiece, other parcels, or postal machinery if mechanical sortation is used.

Domestic Mail Manual (DMM)

* * * * *

C Characteristics and Content

* * * * *

C700 Package Services

* * * * *

— *Mail Preparation and Standards, Pricing and Product Design, 5-3-01*

[Revise 2.0 by deleting 2e and 2f, renumbering 2g through 2j as 2e through 2h, and amending renumbered 2h as follows. For your convenience, the entire revised 2.0 is presented here:]

2.0 NONMACHINABLE PARCEL POST

Mailpieces described in this section and mailed at the Inter-BMC/ASF Parcel Post, Intra-BMC/ASF Parcel Post, and DBMC Parcel Select rates are subject to the applicable nonmachinable surcharge in R700 unless the applicable special handling fee is paid. An oversized parcel as described in 1.0c is not subject to the nonmachinable surcharge. Mailpieces are nonmachinable if they meet any of the following criteria:

- a. A parcel more than 34 inches long, 17 inches wide, 17 inches high, or weighing more than 35 pounds.
- b. A parcel containing more than 24 ounces of liquid in glass containers, or 1 gallon or more of liquid in metal or plastic containers.
- c. An insecurely wrapped or metal-banded parcel.

Special Services Barcoded Label Deadline — Internal Revenue Service Exception

The compliance deadline for barcoding Special Services labels is May 1, 2001, for all mailers, except the Internal Revenue Service (IRS). This deadline applies to any mail bearing the following labels:

- PS Form 3800, *Certified Mail Receipt*
- PS Form 3813-P, *Insured Mail Receipt*
- Label 200, *Registered Mail*
- PS Form 3804, *Return Receipt for Merchandise*
- PS Form 8099, *Receipt for Recorded Delivery*

Offices should accept nonbarcoded mail from the IRS until **July 14, 2001**. Although the IRS has an extension until July, they anticipate that 70 percent of their mail volume will be converted to the barcoded format by May 31. The remaining volume will be converted by July 14.

As information, the majority of the IRS's mail is generated out of 10 service centers located in the following areas: Andover, MA; Atlanta, GA; Austin, TX; Brook Haven, NY; Cincinnati, OH; Fresno, CA; Kansas City, MO; Memphis, TN; Ogden, UT; and Philadelphia, PA.

All other mail with nonbarcoded Special Services labels received at retail acceptance points on or after May 1 should be refused and returned for resubmission with barcoded Postal Service or vendor-produced labels. Should any nonbarcoded Special Services mail reach its destination point, offices are instructed to:

- Deliver the mail; do not return it to the sender.
- Manually key in the article number on the scanner.
- Capture the recipient's signature.

The goal is to catch and refuse nonbarcoded mail at the acceptance point, not at the delivery point.

Note: If postage is metered and the denied acceptance results in a new date of acceptance, customers should re-meter at zero postage with a new meter date.

For more information, contact Tandelyia Samuels at 703-292-3803.

— *Special Services,
Core Business Marketing, 5-3-01*

APO/FPO Changes

Make the following changes to the most recent APO/FPO table in *Postal Bulletin 22048 (4-19-01)*.

APO/FPO	Action	Effective Date	See Restrictions
09781	Close	Immediately	
09788	Close	Immediately	
09794	Close	Immediately	
96547	Activate	Immediately	B-F-U3

— *International Network Operations, Network Operations Management, 5-3-01*

Fraud Alert

Withholding of Mail Orders

Withholding of mail orders is enforced by postmasters at the cities listed below:

State/City	Names Covered
IL, Chicago 60626-8410	Any And All Names Excluding The Surname Aina, P.O. Box 268410
NJ, Mystic Island 08087-5538	Armando J. Nunez, P.O. Box 1538
PA, Altoona 16602-7372	Any And All Of Various Names Other Than The Surname Kibe, 1716 E. Pleasant Valley Blvd., Trlr. 14
PA, Bellwood 16617-0305	Any And All Of Various Names Other Than The Surname Kibe, P.O. Box 305

— *Recorder's Office, Judicial Officer, 5-3-01*

Invalid Express Mail Corporate Account Numbers

These numbers are to be posted and used by retail/acceptance clerks. This listing supersedes all previous notices, which must be recycled. Retail/acceptance clerks must not accept Express Mail shipments bearing any of the invalid numbers (listed below) in the “customer

number” or “agreement number” section of the label or form.

Note: The first 6 digits of a 9-digit Custom Designed Service and Next Day Pickup Service Agreement make up the Corporate Account Number.

005402	019434	029662	065908	080280	100456	115756	142842	173062	210308	276774	309018	330120
005451	019438	029724	066112	080283	102516	117059	142859	174067	210412	277017	311672	330301
005662	019681	030019	066113	080432	103180	117096	142867	174076	210564	277037	311677	330407
005786	019716	030108	066404	080463	103278	117103	142884	174088	210660	277112	311688	330712
005793	020120	030501	067291	080482	103306	117161	146012	175078	210670	277408	314369	330734
005806	020140	033225	067294	080516	103343	117271	146144	175080	220244	278006	314715	330832
005921	020164	036004	067388	080615	103346	117335	146182	175081	220378	278020	321018	331009
005949	020547	037130	068361	085535	103355	117354	146233	175088	220692	278831	321034	331045
006098	020575	040041	068399	085540	103815	117422	146279	176141	220725	280168	321049	331217
006099	021095	041146	068456	085799	103836	117515	146352	180049	221144	281137	321052	331640
006318	021275	041361	068480	085931	105196	117545	146536	180064	221414	282665	321118	332119
007064	021364	042002	069187	088061	105794	117564	146544	180076	222100	283172	321168	332135
007196	021643	042023	069343	088263	105836	117679	146555	181033	223018	283393	321222	332243
008125	021834	046063	069717	088696	105839	117704	146609	183032	224018	283492	322013	332671
008188	021914	047131	069728	088699	105883	117823	146652	184049	224026	283498	322038	332726
008310	022046	050079	069845	088704	105890	117852	146667	185022	225020	284005	322056	332851
008895	022055	053012	069880	089095	105925	117882	146670	186030	232130	286009	322101	332956
009105	022263	053030	070116	089242	106321	117997	146687	187072	232139	286122	322116	333004
009230	022473	054009	070139	089987	107163	118047	146698	188004	235240	286145	322226	333036
009377	022479	054294	070266	090138	107347	118256	146716	191052	235384	287040	322237	333072
009480	022876	055105	070327	090317	108021	118538	146767	191646	240054	287042	322306	333078
009506	023592	055145	070347	091096	108588	118549	146782	191767	240066	292262	322316	333087
010232	023641	055234	070468	092286	108910	118661	146797	192207	245003	292369	322381	333677
010404	023642	060001	070502	092466	109001	118696	146834	192600	249108	293316	322392	333733
010646	025193	060198	070611	092752	109229	118784	148330	193645	252001	296197	322669	333844
010662	025341	060314	070697	092889	109425	119238	148401	196059	253172	296414	322678	334062
011155	025386	060353	070926	093066	109954	119347	150032	196162	257118	296476	322777	334194
011216	026087	060445	071010	093234	110263	119465	150246	197114	257146	296489	322844	335170
012327	026217	060487	071011	094448	110732	119554	151126	198052	257147	300064	322991	335200
012361	026400	060740	071064	094467	110883	120297	152110	198229	257148	300155	322995	335222
014022	026474	060946	071155	094563	111135	120317	152195	198239	257151	300499	323478	335346
014308	026608	061011	071239	094648	111429	122187	152201	198249	260038	300505	323558	335557
014546	027017	061026	071246	095413	111820	125030	152231	199063	263002	300686	323583	335909
014790	027046	061097	075260	095651	111922	125193	152275	199071	271178	300910	323640	335964
014901	027795	061515	075327	096476	112182	125387	152392	200159	271190	301024	323736	336039
014995	027822	062102	075909	096614	112215	125404	152632	200473	272005	301095	325076	336068
015339	028027	063134	075925	096645	112943	125442	152724	200506	272217	301103	325112	336123
015363	028046	063152	076027	096771	113109	126066	152857	200523	272245	301129	325418	336167
015583	028136	063306	076099	097231	113279	130051	152920	200589	272345	301170	325862	336475
015657	028327	064078	076188	097270	113520	142059	156105	200590	273023	301210	325900	336527
016292	028425	064183	076303	097353	113993	142070	156139	200625	274004	301227	326297	336580
016770	028528	064237	076945	097474	114185	142087	156188	200828	274053	301246	326505	336604
016841	028638	064257	076996	097614	114348	142116	156225	200896	274200	301261	326622	336821
016904	028768	064474	077111	097867	114513	142117	159206	200941	274251	301294	327000	337043
018091	028833	064552	077594	097970	115079	142153	165040	200991	274999	301314	327004	337062
018118	028955	064601	078246	098045	115089	142161	165192	206132	275003	302591	327770	337099
018402	028966	064729	078443	098295	115180	142171	165193	207170	275017	302831	327802	338059
018482	029060	064945	078893	098444	115211	142296	170129	207243	275030	303725	328072	338060
018507	029251	065094	079794	098560	115227	142415	170136	207376	275031	305001	328762	338117
018795	029271	065451	080036	098691	115396	142461	170326	207902	275153	305057	328826	338322
018970	029464	065508	080063	100020	115441	142483	171216	207910	275404	305089	328890	339394
019047	029592	065644	080081	100035	115501	142502	171242	207925	275600	306503	328940	339620
019257	029638	065669	080085	100149	115537	142730	171270	207936	276011	306630	328985	339726
019348	029653	065889	080123	100152	115700	142827	172055	208780	276145	309001	329541	340000

340009	402051	452070	489476	553214	606304	656121	730162	770760	809002	898099	906018	921185
340068	402067	452242	490096	553811	606534	656131	730223	770775	809037	900002	906241	921241
340169	402191	452514	490494	553911	606618	657135	730640	770795	812046	900006	906464	921291
340280	402330	452981	490503	554234	606660	658131	731641	771088	815062	900017	906524	921385
340424	402413	452995	490630	554305	606796	658157	740303	773005	815110	900030	906589	921427
340643	402452	454664	490667	554601	606850	658251	740489	773048	816184	900057	906628	921470
340721	402497	454798	490672	554619	607270	662358	740777	780121	816403	900059	906968	921473
340784	402508	460076	492083	554637	607558	665165	740823	782046	816406	900065	906974	921499
340815	402728	460091	492127	554638	607916	666070	741117	782078	820750	900117	907013	921511
340843	405158	460120	493313	554661	608112	666690	741621	782512	830072	900118	907028	921540
340926	410008	461079	494231	554712	608265	668135	741684	782938	830502	900119	907114	921563
344002	423039	462022	497140	554745	608544	680041	741723	782940	837105	900149	907248	921575
344109	424020	462327	499030	554765	609012	681104	743101	782974	840113	900170	907276	921603
344208	424073	462396	501014	554768	609324	681309	749179	782994	840265	900175	907460	921650
349003	430093	462738	503121	554776	611193	685120	750262	784160	840461	900289	907492	921653
349228	430139	462785	515080	554808	628087	701025	750425	784361	840589	900296	907607	921759
349441	430141	468056	522029	554813	629023	701142	751033	784411	840594	900307	907793	921933
349515	432146	468115	524006	554827	629123	701326	752011	786012	841028	900313	910433	921996
349537	432220	468221	525055	554921	631232	701381	752187	786111	841051	900427	911329	922237
349665	432308	470035	527035	570032	631323	701487	752245	787064	841078	900441	913037	922256
349723	432727	471110	527041	570120	631439	701615	752289	787456	841112	900450	913395	922266
349805	432918	473138	527043	571014	631555	701682	752299	787615	841143	900472	913799	922294
350081	436371	474007	531375	571115	631960	701804	752328	787706	841224	900490	913953	924293
351067	436446	476045	531380	573041	641006	701806	752467	787754	841264	900598	914018	924466
352076	437055	480166	531523	577001	641073	701839	752507	787834	841364	900638	914230	924507
352478	441006	480174	531623	591130	641100	701969	752552	787863	841855	900650	914231	924564
352673	441025	480180	531624	598654	641109	701981	752584	787883	841997	900661	914244	924659
352785	441027	480338	531638	600002	641110	705009	752712	787918	843037	900673	914494	924672
352790	441137	480490	531646	600095	641115	705049	752725	787959	846138	900698	914788	926013
357009	441145	480610	531679	600166	641121	705182	752730	787979	846239	900719	914845	926051
362040	441155	480633	531681	600240	641127	705189	752909	787997	846246	900720	915014	926063
362062	441227	480924	531697	600300	641137	706128	756022	787998	846247	900723	915029	926078
363034	441231	480926	531700	600315	641141	706166	756024	788070	847140	900724	915184	926108
370028	441350	481009	531711	600403	641162	706175	757167	788077	850660	900830	915354	926131
372022	441415	481113	531723	600420	641171	708242	757197	790009	852073	901162	915367	926136
372314	441421	481567	531753	600558	641178	708321	757259	790015	852117	901276	915661	926141
372566	441459	481764	532274	600996	641182	708343	757619	791001	852664	901502	915695	926152
372667	441463	481838	532384	601113	641186	708362	759009	791168	852999	901512	916009	926163
372701	441488	481877	532410	601134	641209	708387	760024	791335	853054	901530	917062	926339
372720	441508	481925	532449	601140	641210	708411	760029	794043	853313	901808	917197	926412
372896	441512	481962	532456	601207	641265	708436	760060	795003	853334	901904	917210	926507
372968	441528	482321	532492	601258	641326	708460	760066	795010	853359	901930	917218	926511
372980	441560	482344	532581	601339	641366	708466	760131	799011	853399	901950	917251	926514
372982	441564	482942	532619	601714	641429	708479	760139	799068	853452	902165	917290	926642
373025	441576	482966	532622	602014	641464	708480	760588	799120	853500	902247	917372	926673
374050	441590	483083	532740	602260	641536	708484	760601	799152	853591	902341	917387	926696
374066	441596	483120	532751	602536	641560	708486	761006	800108	853637	902556	917413	926700
376106	441601	483150	532846	602622	641591	708503	761010	802118	853646	902558	917525	926828
376146	441614	483181	532859	602737	641623	708538	761055	802225	853699	902627	917675	926869
377128	441624	483199	532930	603093	641682	708539	761122	802340	860139	902709	917770	926895
378126	441777	483508	532989	604300	641719	708544	761678	802730	871592	902905	917992	927037
378145	441821	483627	537367	604380	641732	708551	761698	802797	880005	903754	918016	927288
381342	441867	485007	537377	604806	641740	708572	762001	802906	891324	903908	918110	927294
381459	441905	485158	543600	604867	641788	708604	762055	802949	891356	903969	918114	927295
381497	441989	485164	544033	604886	641817	708608	765567	802998	891375	904032	918386	927297
381531	441998	485244	549209	605016	641830	708617	766518	803141	891382	904356	918922	927301
381541	444062	485302	549212	605126	641838	708625	770012	803297	891448	904372	920035	927313
381811	444826	486260	551096	605148	641874	708747	770098	805134	891734	904506	920064	927324
381861	445045	486313	551184	605678	641912	708762	770154	805498	891805	904546	920072	927332
383130	445125	486319	551290	605681	641988	717007	770205	805608	891836	904609	920215	927375
387014	450059	488504	551294	605785	641992	720017	770281	805609	891840	904641	920346	927424
392629	450069	488764	551319	605862	648107	722249	770648	806181	898008	904676	920350	927568
392637	450202	489389	551680	605906	652130	727071	770713	806183	898010	904680	921126	927832
402033	452064	489471	551854	606073	652410	730020	770743	808019	898052	904711	921173	928199

928287	932746	940235	941684	949584	951916	953359	958820	967439	968667	972610	982333	995825
928387	933528	940406	941686	949594	951937	953360	958869	968047	968691	974168	982351	995828
928417	934284	940595	941773	949620	951951	954471	958906	968158	968776	976064	982398	997313
928440	935136	940883	945708	949633	951957	955312	958924	968351	968949	980399	984160	998194
928567	937407	940902	947261	950221	952203	958177	958930	968352	969106	980445	985218	999217
928613	937520	940955	948175	950389	952344	958227	958957	968393	969137	980446	985231	
930229	937613	940963	948378	950657	953212	958447	958990	968417	970129	980457	992628	
930302	937628	941191	948381	950904	953213	958473	959042	968422	970367	980784	992649	
931151	937678	941213	948455	951217	953232	958522	959075	968431	970387	980895	992704	
931214	937681	941233	948470	951352	953233	958538	960074	968434	970461	980951	995162	
931419	937696	941270	948583	951357	953252	958676	960081	968544	970644	980956	995273	
931554	937707	941334	948677	951587	953262	958688	960086	968552	970697	981856	995307	
931646	937809	941352	948698	951724	953320	958728	960511	968625	970878	982139	995386	
931923	937838	941462	949550	951791	953343	958752	967201	968648	970901	982165	995655	
932583	937871	941554	949567	951911	953358	958788	967430	968658	972244	982185	995700	

— Express and Priority Mail, Marketing, 5-3-01

Missing, Lost, or Stolen U.S. Money Order Forms

Do Not Cash — Upon Receipt, Notify Local Postal Inspectors

This listing will be provided to all Postal Service employees responsible for accepting and cashing Postal money orders. All interim notices should be destroyed when the numbers listed appear in the *Postal Bulletin*. The

actual serial numbers consist of the first 10 digits on the money orders. Check for altered dollar amounts by holding money orders to the light.

011 582 1889 to 011 582 1899	360 324 2326 to 2399	394 822 3243 to 3278	409 072 3941 to 3999
011 588 2900 to 011 588 3099	362 861 3064 to 3099	394 990 1810 to 1899	410 491 2311 to 2399
012 579 5675 to 012 579 5699	373 006 2176 to 2199	395 343 3264 to 3299	410 694 8400 to 8599
013 289 6176 to 013 289 6199	374 768 2600 to 2699	395 373 3035 to 3099	410 775 1500 to 1599
013 610 0014 to 013 610 0099	375 169 4400 to 4599	395 396 9649 to 9799	410 795 7927 to 7999
014 932 1000 to 014 932 1099	375 829 3400 to 3499	395 970 3240 to 3299	410 867 0917 to 0966
014 972 0800 to 014 972 0899	375 851 9100 to 9199	397 622 4054 to 4099	410 867 0970 to 0999
015 363 0007 to 015 363 0099	376 196 0911 to 0999	397 819 8902 to 8999	411 868 1023 to 1199
018 986 5264 to 018 986 5299	378 085 3679 to 3699	398 149 7200 to 7699	411 922 2322 to 2399
019 518 2814 to 019 518 2899	378 351 1063 to 1099	399 070 0872 to 0899	412 193 0900 to 0999
020 972 8948 to 020 972 8999	379 843 5100 to 5199	399 156 7119 to 7199	412 395 8599 to 8699
022 021 9110 to 022 021 9181	380 093 9600 to 9699	399 203 5064 to 5099	412 485 6500 to 6599
022 037 1411 to 022 037 1499	380 165 1165 to 1199	399 296 9910 to 9999	412 485 6610 to 6699
024 380 4100 to 024 380 4199	381 325 4500 to 4599	399 396 8935 to 8999	412 885 5953 to 5999
025 092 0987 to 025 092 0999	381 604 2510 to 2699	399 792 7775 to 7799	414 193 3608 to 3674
028 191 1852 to 028 191 1999	381 645 9525 to 9599	399 792 8300 to 8399	414 193 3677 to 3699
028 850 3000 to 028 850 3199	383 314 3968 to 3999	400 427 1051 to 1999	414 411 7348 to 7399
210 221 0548 to 210 221 0599	383 892 1000 to 1344	401 045 1505 to 1549	414 640 0757 to 0799
227 275 9400 to 227 275 9999	383 892 1382 to 1399	401 045 1571 to 1599	414 965 1727 to 1799
273 070 8059 to 273 070 8099	384 925 3641 to 3654	401 294 2700 to 2799	417 302 8104 to 8199
273 775 7700 to 273 775 7899	385 568 2331 to 2399	401 310 9505 to 9599	417 387 6532 to 6599
302 000 0000 to 302 123 9999	385 599 7554 to 7575	401 382 5312 to 5399	417 496 6800 to 6999
349 746 2056 to 2099	385 774 2024 to 2099	402 578 7876 to 7899	417 871 9250 to 9299
350 518 7350 to 7374	386 624 1412 to 1599	403 125 6744 to 6799	417 930 9533 to 9599
360 011 1690 to 1699	386 883 8936 to 8999	403 260 7000 to 7499	418 164 6500 to 6799
360 168 6008 to 6099	387 314 5574 to 5599	403 280 6470 to 6499	418 423 9863 to 9899
360 173 8800 to 8899	387 837 6300 to 6399	403 685 8600 to 8699	418 633 5922 to 5999
	388 828 0656 to 0699	404 003 0300 to 0399	418 719 8520 to 8599
	389 696 2400 to 2799	404 041 8838 to 8899	418 744 2235 to 2299
	389 846 3104 to 3135	404 071 4268 to 4299	418 962 2848 to 2899
	389 846 3145 to 3195	404 347 5356 to 5399	419 543 0286 to 0299
	389 887 9211 to 9230	404 347 5548 to 5599	419 730 0300 to 0399
	389 887 9234 to 9299	404 726 4500 to 4599	420 277 0015 to 0049
	390 001 3182 to 3199	404 961 5001 to 5199	420 599 0734 to 0798
	390 001 3500 to 3699	405 325 0188 to 0198	420 661 4115 to 4199
	390 545 5974 to 5999	406 009 4587 to 4599	420 758 9500 to 9699
	391 104 6146 to 6199	406 260 6830 to 6899	420 969 3951 to 3971
	391 574 1466 to 1499	406 459 6641 to 6999	420 969 3973 to 3999
	391 783 3020 to 3599	406 733 3000 to 3999	421 116 3565 to 3599
	391 792 6100 to 6199	407 545 1557 to 1599	421 130 9300 to 9399
	392 668 2956 to 2999	407 594 0412 to 0599	421 313 4500 to 4999
	392 854 8500 to 8899	407 692 9100 to 9299	421 364 5537 to 5599
	393 584 7566 to 7699	407 959 2190 to 2199	421 656 2609 to 2699
	393 650 0074 to 0099	408 265 2275 to 2288	421 988 9700 to 9799
	393 838 8316 to 8499	408 499 7700 to 7799	422 172 4667 to 4699
	393 893 6007 to 6099	408 499 7900 to 7999	422 484 4212 to 4299
	394 126 6907 to 6999	408 682 8484 to 8599	422 556 1270 to 1299
	394 189 0405 to 0599	408 698 7015 to 7099	422 587 7024 to 7099

422 819 7533 to 7599	451 115 4110 to 4125	463 227 7711 to 7799	479 748 9680 to 9699
422 842 5073 to 5087	451 115 4127 to 4199	463 414 4869 to 4899	479 860 7000 to 7199
422 907 7563 to 7599	451 746 0700 to 0799	463 808 3484 to 3499	480 526 2000 to 2099
424 500 6050 to 6099	452 265 0074 to 0099	463 945 7400 to 7899	480 640 6330 to 6399
424 641 8500 to 8599	452 265 0246 to 0299	464 629 9000 to 9399	480 658 0568 to 0599
424 871 6600 to 6699	452 265 0335 to 0999	464 711 4332 to 4399	480 689 5100 to 5199
425 298 2352 to 2399	452 509 1169 to 1199	465 692 3963 to 3999	481 072 9463 to 9499
425 418 4269 to 4299	452 855 6471 to 6499	465 698 8300 to 8599	481 673 0074 to 0095
425 418 4405 to 4499	452 890 4679 to 4799	465 743 7745 to 7799	482 527 1500 to 1599
426 547 4566 to 4599	452 900 8215 to 8238	466 798 6056 to 6067	482 541 5255 to 5299
427 412 6337 to 6499	453 117 9146 to 9199	467 147 4300 to 4399	482 729 6800 to 6899
427 481 0900 to 0999	453 334 3631 to 3699	468 079 5782 to 5799	483 363 7207 to 7299
428 027 2742 to 2752	453 603 7841 to 7891	469 067 2817 to 2899	483 402 2356 to 2399
429 474 4172 to 4199	453 650 1140 to 1199	469 127 8000 to 8199	483 486 5100 to 5199
429 889 2900 to 2999	453 741 1300 to 1399	469 213 0359 to 0399	483 632 1521 to 1599
430 150 4401 to 4599	454 013 2919 to 2999	469 213 0500 to 0599	483 632 2600 to 2799
430 172 9800 to 9899	454 186 2411 to 2499	469 561 8011 to 8099	483 849 1615 to 1699
430 177 1900 to 2099	454 268 4883 to 4899	469 658 1961 to 1999	484 174 4803 to 5299
430 444 9500 to 9699	454 302 5400 to 5499	469 666 9900 to 9999	484 323 8900 to 9199
430 664 4070 to 4099	454 490 8300 to 8399	469 678 1900 to 1999	484 680 5000 to 5038
432 168 8419 to 8499	454 547 7434 to 7499	469 781 4900 to 4999	484 680 5040 to 5074
432 708 6800 to 6999	454 922 4867 to 4895	469 947 6960 to 6999	484 680 5077 to 5099
432 744 1544 to 1599	455 221 1348 to 1499	470 755 5800 to 5818	485 029 4913 to 4999
432 995 9775 to 9799	455 364 2147 to 2199	471 918 0300 to 0999	486 176 0600 to 0699
433 003 5800 to 5899	455 399 5400 to 5499	471 985 2408 to 2419	486 559 7555 to 7599
433 757 3047 to 3099	455 476 0676 to 0699	472 191 6700 to 6799	486 696 3023 to 3199
433 765 4003 to 4099	455 543 0618 to 0699	472 270 2555 to 2599	488 173 7900 to 7999
434 482 7060 to 7199	456 410 9006 to 9099	472 987 0213 to 0241	488 206 4100 to 4199
434 513 2386 to 2399	456 470 4146 to 4299	472 987 0290 to 0299	488 226 0200 to 0299
434 968 3076 to 3092	456 619 4460 to 4499	473 151 2069 to 2199	488 709 3906 to 3999
435 303 1831 to 1842	457 333 2686 to 2699	473 666 9138 to 9199	488 855 8359 to 8399
435 303 1986 to 1999	457 729 1767 to 1777	473 952 3429 to 3499	489 181 8963 to 8999
435 666 6092 to 6399	457 937 8615 to 8699	474 108 5402 to 5499	489 223 2000 to 2099
436 082 6400 to 6899	458 028 9810 to 9899	474 356 5193 to 5299	489 311 1930 to 1999
436 160 6441 to 6499	458 057 2712 to 2999	474 949 3366 to 3399	489 318 6200 to 6300
437 316 7115 to 7199	458 069 9537 to 9599	475 134 9362 to 9399	489 384 0027 to 0099
437 427 0500 to 3499	458 069 9665 to 9699	475 167 9667 to 9699	489 427 0658 to 0899
439 179 2300 to 2399	458 337 5222 to 5299	475 319 3415 to 3499	489 997 5252 to 5299
439 310 0458 to 0499	458 354 7653 to 7999	475 319 3649 to 3799	490 669 5850 to 6099
440 698 1947 to 1999	458 671 8678 to 8699	475 340 6400 to 6599	490 717 7080 to 7099
440 858 6300 to 6399	458 671 8721 to 8798	475 424 8410 to 8499	490 721 6000 to 6099
440 858 6420 to 7299	458 847 5044 to 5999	475 629 9156 to 9199	490 793 1500 to 2099
441 199 1655 to 1699	459 274 7624 to 7699	475 850 6101 to 6199	490 886 8171 to 8199
443 127 3648 to 3699	459 365 5432 to 5499	475 875 2500 to 2599	490 977 9221 to 9240
443 127 4000 to 4099	459 378 5764 to 5799	476 169 8264 to 8299	491 258 8100 to 9099
443 673 7900 to 7999	459 472 4816 to 4999	476 189 3000 to 3499	491 567 1376 to 1399
443 800 9335 to 9399	460 349 6878 to 6899	476 331 2480 to 2499	492 254 4800 to 4899
444 382 8822 to 8899	460 550 1909 to 1999	477 289 8601 to 8699	492 283 5100 to 5199
444 390 1667 to 1699	460 997 5234 to 5299	477 681 5206 to 5299	492 610 6813 to 6899
444 457 3854 to 3899	461 973 6443 to 6499	478 010 4243 to 4268	493 394 5568 to 5599
450 048 4173 to 4199	462 152 0107 to 0299	478 010 4270 to 4291	493 470 2562 to 2599
450 048 4442 to 4699	462 274 1072 to 1099	478 450 5071 to 5099	493 473 7700 to 7799
450 560 5173 to 5199	462 277 8373 to 8399	478 469 7838 to 7858	493 716 2153 to 2199
450 620 3077 to 3099	462 554 6051 to 6099	478 469 7883 to 7899	494 206 2972 to 2999
450 620 3135 to 3199	463 011 5529 to 5540	479 280 9800 to 9899	494 217 3446 to 3999
450 780 2716 to 2799	463 176 4115 to 4199	479 365 9116 to 9176	494 224 0500 to 0599
450 801 2700 to 2799	463 176 4229 to 4299	479 412 9900 to 9999	495 145 0600 to 0699
451 109 2967 to 2984	463 185 2600 to 2799	479 667 6190 to 6199	496 209 7425 to 7499

496 213 8728 to	8799	612 774 2111 to	2199	635 559 3449 to	3499	648 163 5300 to	5499
496 474 5226 to	5248	612 774 2254 to	2299	636 289 6214 to	6299	648 722 5283 to	5299
497 053 8517 to	8699	612 774 2500 to	2599	636 634 8007 to	8042	648 892 3164 to	3199
497 854 8673 to	8699	614 469 0979 to	0999	637 150 1200 to	1299	649 100 3989 to	3999
498 449 8888 to	8899	614 474 3000 to	3099	637 562 5828 to	5899	649 647 0370 to	0399
498 929 8285 to	8499	614 521 3490 to	3499	638 042 1647 to	1699	649 647 0522 to	0599
498 936 5310 to	5399	614 645 1800 to	1899	638 049 4984 to	4999	649 647 5237 to	5399
499 016 5425 to	5499	614 832 1100 to	2099	638 318 1115 to	1199	649 647 9100 to	9299
499 440 8575 to	8899	615 017 7505 to	7599	638 318 1453 to	1499	649 666 7800 to	8299
499 731 6717 to	6799	617 711 6609 to	6699	638 885 0000 to	0299	650 114 7707 to	7719
500 064 1858 to	1869	617 760 5266 to	5299	638 903 4362 to	4373	650 130 3400 to	3599
500 070 5725 to	7799	617 813 3601 to	3699	639 415 1929 to	1999	650 213 0406 to	0499
600 645 3223 to	3299	618 840 9200 to	9299	639 415 2019 to	2099	650 555 1749 to	1799
601 339 1200 to	1399	619 551 7229 to	7299	639 420 6200 to	6299	650 564 1900 to	1999
601 653 5884 to	5899	619 859 3000 to	3099	639 469 3517 to	3799	650 627 4212 to	4299
601 661 7700 to	7799	620 073 9400 to	9499	639 605 2143 to	2199	650 736 2043 to	2099
601 682 5343 to	5399	621 614 7907 to	7930	639 657 8600 to	8799	650 739 1540 to	1699
601 928 1600 to	1699	621 614 7932 to	7999	640 289 7500 to	7599	651 741 4415 to	4499
602 512 2972 to	2999	621 648 8021 to	8199	640 289 7700 to	7999	651 882 2800 to	2899
602 555 2400 to	2799	621 648 8500 to	8599	641 170 4420 to	4499	652 754 6317 to	6399
602 829 7061 to	7099	621 904 8351 to	8599	641 318 3133 to	3199	653 131 4945 to	4999
603 483 9572 to	9599	621 916 1978 to	1989	641 378 6500 to	6999	653 426 3300 to	3399
603 490 7200 to	7299	622 989 8032 to	8099	641 383 8739 to	8799	653 455 4874 to	4899
603 678 7100 to	7199	623 076 9300 to	9399	641 877 3187 to	3299	654 238 0000 to	0399
603 678 7662 to	7699	623 819 5006 to	5099	641 877 3310 to	3399	654 404 3065 to	3092
603 678 7902 to	7999	623 895 8200 to	8399	642 355 8094 to	8199	654 962 2900 to	3199
603 678 8418 to	8499	623 917 0000 to	0099	642 355 8308 to	8999	655 103 5081 to	5199
603 678 8700 to	9999	623 917 0200 to	0299	642 900 0018 to	0099	655 523 2600 to	2999
604 086 0880 to	0899	624 468 5288 to	5299	643 030 6254 to	6299	656 305 2448 to	2499
604 349 1414 to	1499	624 665 3162 to	3198	644 066 0882 to	0899	657 347 4438 to	4999
604 503 7776 to	7799	625 088 6735 to	6799	644 069 0600 to	0699	657 710 8100 to	8999
605 520 9037 to	9099	625 916 9500 to	9799	644 077 7506 to	7699	657 780 0985 to	0999
605 685 4010 to	4099	625 968 8956 to	8999	644 085 8157 to	8199	658 586 1400 to	1499
605 988 6467 to	6499	627 005 3938 to	3999	644 112 9839 to	9899	658 877 8000 to	8199
607 689 7951 to	7960	627 384 3907 to	4099	644 373 9083 to	9099	658 880 8000 to	8199
607 728 1276 to	1299	627 496 7549 to	7599	644 380 1460 to	1499	659 398 7300 to	7399
608 727 7100 to	7199	627 708 3605 to	3699	644 733 4715 to	4799	659 706 8113 to	8199
608 727 7273 to	7599	627 776 2500 to	2599	644 900 9712 to	9799	659 846 7837 to	7899
608 813 9950 to	9999	628 226 3100 to	3199	644 901 0109 to	1299	660 510 4100 to	4199
609 067 5325 to	5399	628 814 4702 to	4799	644 901 1325 to	1399	660 673 0400 to	0599
609 067 5488 to	5499	628 851 9689 to	9699	644 923 6800 to	7799	661 488 5000 to	5099
609 067 5600 to	5699	629 510 7200 to	7299	644 932 4655 to	4699	661 609 9100 to	9199
609 289 6123 to	6199	629 964 4200 to	4294	645 318 7240 to	7499	661 716 9420 to	9499
609 438 4400 to	4499	630 389 3056 to	3071	645 333 1766 to	1799	661 906 6522 to	6599
609 493 1100 to	1199	630 463 0588 to	0599	645 790 8632 to	8699	662 021 8332 to	8399
609 766 8091 to	8999	631 459 9117 to	9199	645 821 0657 to	0699	662 068 0700 to	0899
609 825 4100 to	4115	631 762 9325 to	9399	645 930 7948 to	7999	662 553 0774 to	0799
609 884 2981 to	2999	632 217 4933 to	4999	645 975 0737 to	0762	663 078 7034 to	7099
609 893 1000 to	1099	632 500 0000 to	9999	646 242 6200 to	6299	663 763 5300 to	5399
610 092 3200 to	3299	633 110 4165 to	4199	646 270 7639 to	7799	663 883 7039 to	7499
610 582 4200 to	4299	633 110 4303 to	4499	646 798 4000 to	4999	664 253 8000 to	8499
611 879 6939 to	6999	633 438 6429 to	6599	647 048 7035 to	7099	664 656 3055 to	3099
612 291 8013 to	8099	633 588 7173 to	7182	647 049 2900 to	2999	665 174 6400 to	6499
612 751 5171 to	5199	634 725 0700 to	0799	647 398 8300 to	8399	665 274 8208 to	8299
612 751 5226 to	5299	634 803 3239 to	3299	647 398 8481 to	8499	665 669 5400 to	5499
612 751 6083 to	6099	634 807 2474 to	2499	647 437 3000 to	4999	666 132 8226 to	8299
612 751 6268 to	6299	634 827 5900 to	5999	647 811 2188 to	2199	666 696 2209 to	2299
612 751 6572 to	6599	634 886 3428 to	3499	648 009 6057 to	6099	666 696 2309 to	2399

667 032 9300 to	9399	690 291 1361 to	1371	702 264 7569 to	7599	845 727 2100 to	2199
667 729 5529 to	5599	690 788 2877 to	2899	702 713 1800 to	1809	845 746 2618 to	2635
668 383 8400 to	8699	690 893 5344 to	5399	702 821 5730 to	5799	846 390 7531 to	7599
670 368 3400 to	3499	690 893 5512 to	5599	702 821 5805 to	5899	846 918 0572 to	0599
670 369 7336 to	7399	690 904 1300 to	1599	702 878 0114 to	0199	847 284 2481 to	2499
670 750 7169 to	7199	690 941 6000 to	6199	740 002 7710 to	7719	847 374 7055 to	7065
671 046 6200 to	6399	691 313 6383 to	6399	806 087 1100 to	1499	847 636 5304 to	5399
671 251 5448 to	5499	691 313 6600 to	6699	806 268 9275 to	9299	847 700 5447 to	5499
671 926 5600 to	5799	691 582 8003 to	8099	806 534 3400 to	3477	847 723 7500 to	7599
672 444 2000 to	2999	691 664 1800 to	1999	807 342 3283 to	3399	849 485 3427 to	3499
672 828 3410 to	3499	691 664 2400 to	2499	808 086 7100 to	7199	849 608 1357 to	1399
673 167 5776 to	5799	692 727 9362 to	9399	808 090 3440 to	3499	849 792 2600 to	2699
675 464 3700 to	3799	692 798 1800 to	1899	808 325 5161 to	5699	850 546 1862 to	1899
675 464 4000 to	4199	693 249 0779 to	0799	808 784 8000 to	8299	851 143 6826 to	6844
676 365 5958 to	5999	693 249 0877 to	1699	830 125 0672 to	0699	851 209 9880 to	9899
676 669 1024 to	1099	693 445 0566 to	0999	830 602 5800 to	5999	851 928 9221 to	9299
677 126 6734 to	6799	693 448 8500 to	8999	830 610 3700 to	3799	852 589 6560 to	6599
677 333 9979 to	9999	693 645 9583 to	9599	830 983 3500 to	3599	853 049 3646 to	3699
677 466 1088 to	1099	693 965 4200 to	4299	830 983 3635 to	3699	854 304 4089 to	4999
678 071 4500 to	4799	695 741 2906 to	2999	831 354 1387 to	1399	854 529 2200 to	2299
678 096 7531 to	7599	695 947 8518 to	8599	831 815 8240 to	8299	855 001 6204 to	6249
679 909 2578 to	2599	696 662 8247 to	8299	832 525 3810 to	3899	855 319 9364 to	9399
680 112 9565 to	9599	697 447 8285 to	8296	833 159 1884 to	1899	855 361 3390 to	3399
680 244 0903 to	0999	698 042 4816 to	4899	833 456 2567 to	2599	856 226 0490 to	0499
680 412 6046 to	6099	698 131 2138 to	2157	833 566 3015 to	3071	856 656 5800 to	5999
680 761 6800 to	6899	698 227 0000 to	0099	834 316 5444 to	5499	856 752 0200 to	0299
681 677 0540 to	0699	700 065 2570 to	2599	834 354 8747 to	8766	857 279 3450 to	3499
682 070 1029 to	1099	700 065 4800 to	4899	834 354 8824 to	8838	858 124 7644 to	7699
682 956 6280 to	6299	700 190 3350 to	3359	835 269 5700 to	5799	858 756 3111 to	3299
682 956 6490 to	6599	700 228 6048 to	6099	835 496 7303 to	7399	859 063 8200 to	8699
682 956 6700 to	6799	700 650 0452 to	0499	835 539 5200 to	5999	859 190 0600 to	0644
682 965 1178 to	1199	700 666 1323 to	1349	835 813 3015 to	3099	859 811 2888 to	2899
682 965 1201 to	1299	700 786 9106 to	9142	837 672 8967 to	8999	859 855 8873 to	8999
683 118 2389 to	2399	700 859 0744 to	0758	837 784 3282 to	3292	860 240 0520 to	0599
683 378 2000 to	2099	701 028 6780 to	6899	838 176 8377 to	8399	860 275 3900 to	3999
683 378 2117 to	2299	701 213 3900 to	3999	838 518 1257 to	1299	860 518 9629 to	9699
683 415 1200 to	1499	701 267 2000 to	3999	839 718 8257 to	8299	860 600 0021 to	0999
683 444 8159 to	8199	701 335 7312 to	7399	840 323 0600 to	0699	861 158 2350 to	2599
685 154 7780 to	7789	701 369 2005 to	2050	840 875 6235 to	6299	861 637 6010 to	6099
685 297 7645 to	7699	701 503 2247 to	2299	840 910 0900 to	0999	861 979 7292 to	7499
685 623 5264 to	5299	701 541 2271 to	2299	841 349 5000 to	5099	863 871 5138 to	5199
685 650 9487 to	9499	701 553 6557 to	6599	841 805 7747 to	7899	864 088 8200 to	8299
685 669 4200 to	4299	701 601 3457 to	3499	841 805 7944 to	8099	864 426 3972 to	3999
685 757 8452 to	8499	701 605 5913 to	5999	842 226 0685 to	0695	864 520 6117 to	6136
686 071 2694 to	2799	701 695 3982 to	3999	842 685 4600 to	4699	865 883 6082 to	6099
686 176 3333 to	3354	701 695 4148 to	4199	842 685 4742 to	4999	866 004 3000 to	3999
686 372 3200 to	3299	701 695 4227 to	4299	842 860 0300 to	0399	869 800 0000 to	999 9999
686 644 5879 to	5899	701 708 1741 to	1799	842 898 5582 to	5599	870 054 4814 to	4899
686 899 1371 to	1399	701 736 3966 to	3999	843 062 7100 to	7199	870 491 4812 to	4849
686 931 7636 to	7699	701 838 2800 to	2899	843 077 6288 to	6299	870 536 5820 to	5829
687 601 0973 to	0999	701 941 0600 to	0699	843 077 6378 to	6399	870 541 7167 to	7239
687 614 6774 to	6799	702 171 1603 to	1699	843 758 5769 to	5778	870 575 8155 to	8999
688 120 9000 to	9999	702 195 5109 to	5199	843 786 2554 to	2699	870 589 0485 to	0494
688 314 3107 to	3191	702 254 9300 to	9399	845 656 8165 to	8199	870 691 7060 to	7099

725 464 591	to	4 920	732 355 201	to	5 380	740 265 811	to	6 290	751 539 121	to	9 180
725 475 321	to	5 330	732 472 320	to	2 560	740 299 111	to	9 170	751 541 311	to	1 790
725 711 057	to	1 070	732 541 605	to	1 620	740 299 231	to	9 260	751 757 641	to	7 700
725 738 581	to	8 730	732 572 221	to	2 490	740 329 266	to	9 320	751 936 951	to	7 010
725 981 311	to	1 430	732 586 479	to	6 710	740 889 081	to	9 090	751 951 861	to	1 890
725 987 835	to	7 880	732 994 037	to	4 080	741 010 421	to	0 530	751 999 021	to	9 110
726 060 811	to	0 900	733 163 449	to	3 460	741 113 041	to	3 370	752 139 516	to	9 570
726 391 970	to	2 520	733 297 171	to	7 290	741 373 891	to	4 340	752 182 892	to	2 950
726 484 771	to	4 800	733 446 631	to	7 110	741 452 369	to	2 490	752 206 861	to	7 100
726 493 351	to	5 300	733 474 665	to	4 770	741 492 991	to	3 140	752 295 241	to	5 600
726 504 031	to	4 063	733 704 482	to	4 570	741 553 460	to	3 470	752 731 351	to	1 410
726 504 070	to	4 090	733 751 041	to	1 130	741 764 431	to	4 520	752 767 441	to	7 470
726 504 331	to	4 390	734 009 101	to	9 130	742 178 834	to	8 880	753 008 941	to	9 030
726 563 701	to	4 060	734 290 759	to	0 770	742 325 500	to	5 520	753 194 311	to	4 370
726 599 371	to	9 460	734 389 273	to	9 290	742 325 668	to	5 700	753 620 378	to	0 400
726 626 356	to	6 370	734 440 031	to	0 111	742 408 771	to	8 830	754 013 917	to	3 940
727 182 271	to	2 510	734 797 201	to	7 320	742 512 120	to	2 150	754 161 061	to	1 120
727 416 181	to	6 240	734 939 611	to	9 640	742 684 849	to	4 890	754 358 445	to	8 610
727 481 431	to	1 460	734 950 111	to	0 170	742 839 553	to	9 630	754 410 451	to	0 660
727 749 241	to	9 780	735 120 331	to	0 840	742 913 668	to	3 700	754 438 393	to	8 410
728 382 331	to	2 480	735 283 008	to	3 020	742 917 287	to	7 296	754 493 109	to	3 130
728 702 338	to	2 400	735 293 131	to	3 220	742 921 891	to	1 980	754 664 182	to	4 220
728 915 371	to	5 850	735 635 010	to	5 040	742 983 631	to	3 810	754 816 377	to	6 470
728 953 141	to	3 410	735 783 961	to	3 990	743 020 021	to	0 170	755 487 421	to	7 600
728 954 280	to	4 310	735 803 401	to	3 430	743 206 491	to	6 500	755 592 901	to	3 140
729 169 081	to	9 140	736 005 420	to	5 440	743 235 992	to	6 050	755 790 020	to	0 030
729 363 841	to	3 870	736 366 021	to	6 110	743 940 631	to	0 900	755 791 730	to	1 800
729 682 891	to	3 190	736 624 456	to	4 500	743 978 011	to	8 070	755 926 951	to	7 070
729 838 940	to	9 070	736 670 851	to	1 060	744 234 751	to	4 780	755 934 332	to	4 510
729 839 101	to	9 130	736 767 061	to	7 090	744 499 591	to	9 680	755 957 701	to	8 000
730 077 683	to	7 840	736 767 093	to	7 120	744 626 901	to	6 910	755 962 981	to	3 280
730 109 847	to	9 880	736 982 191	to	2 370	745 388 794	to	8 910	756 035 371	to	5 490
730 373 761	to	3 850	736 982 551	to	2 730	746 446 806	to	6 820	756 301 257	to	1 290
730 501 951	to	2 130	737 110 141	to	0 170	746 818 351	to	8 410	756 371 565	to	1 580
730 519 379	to	9 470	737 185 501	to	5 710	747 245 266	to	5 280	756 876 031	to	6 120
730 569 278	to	9 360	737 317 321	to	7 350	747 364 813	to	4 830	756 876 151	to	6 240
730 711 711	to	1 740	737 517 781	to	7 840	747 501 434	to	1 450	756 970 129	to	0 140
730 722 991	to	3 230	737 628 181	to	8 210	747 739 891	to	0 070	757 059 613	to	9 630
730 845 970	to	5 990	737 634 258	to	4 270	748 148 649	to	8 760	757 078 540	to	8 560
730 888 291	to	8 320	738 361 971	to	1 980	748 259 960	to	9 970	757 086 209	to	6 240
730 927 591	to	7 680	738 447 601	to	7 660	748 565 162	to	5 280	757 240 591	to	0 650
731 307 914	to	7 930	738 648 355	to	8 450	748 874 988	to	5 030	757 277 371	to	7 700
731 402 431	to	2 460	738 849 811	to	9 900	749 137 381	to	7 410	757 291 591	to	2 730
731 407 232	to	7 320	738 892 270	to	2 290	749 190 192	to	0 210	757 964 251	to	4 280
731 588 301	to	8 340	738 997 259	to	7 380	749 685 421	to	5 450	758 105 221	to	5 250
731 767 273	to	7 320	739 161 451	to	1 540	749 846 791	to	6 850	758 324 941	to	5 000
731 781 061	to	1 120	739 219 381	to	9 440	749 993 131	to	3 580	758 593 628	to	3 650
731 837 821	to	7 910	739 740 151	to	0 180	750 071 587	to	1 610	758 709 038	to	9 060
731 841 377	to	1 450	739 793 491	to	3 520	750 408 167	to	8 183	758 744 101	to	4 160
732 018 481	to	8 600	739 793 527	to	3 550	750 438 421	to	8 501	758 850 883	to	0 900
732 067 972	to	8 370	739 942 621	to	2 650	750 743 911	to	4 030	759 152 851	to	2 880
732 188 649	to	8 670	739 999 231	to	9 320	750 779 118	to	9 400	759 740 941	to	1 090
732 193 460	to	3 470	740 011 517	to	1 530	750 910 981	to	1 010	760 004 596	to	4 610
732 201 241	to	1 390	740 030 701	to	0 970	750 960 841	to	0 900	760 118 191	to	8 250
732 220 431	to	0 440	740 261 740	to	1 820	751 296 211	to	6 240	760 155 001	to	5 090

760 378 002 to 8 020	762 524 158 to 4 220	764 284 525 to 4 560	766 158 824 to 8 840
761 055 460 to 5 480	762 584 872 to 4 970	764 526 241 to 6 330	766 205 616 to 5 640
761 504 941 to 5 120	763 155 160 to 5 180	764 601 421 to 1 600	766 388 433 to 8 460
761 516 836 to 6 850	763 178 631 to 8 660	764 650 231 to 0 470	766 509 421 to 9 660
761 516 851 to 6 910	763 506 001 to 6 060	764 984 371 to 4 850	766 572 901 to 3 020
761 613 588 to 3 600	763 522 141 to 2 470	765 042 517 to 2 540	767 024 341 to 4 370
761 688 631 to 8 690	763 717 694 to 7 800	765 194 728 to 4 970	767 326 471 to 6 590
761 805 199 to 5 240	763 826 461 to 6 520	765 638 461 to 8 970	767 332 561 to 2 950
761 826 106 to 6 120	763 900 460 to 0 471	765 813 781 to 4 029	770 915 150 to 5 490
761 881 171 to 1 560	763 900 479 to 0 530	765 879 314 to 9 390	
762 304 144 to 4 170	763 917 271 to 7 750	766 120 286 to 0 320	
762 324 931 to 4 960	764 125 801 to 5 860	766 125 716 to 5 750	
762 439 261 to 9 290			

— Postal Inspection Service, 5-3-01

Counterfeit Canadian Money Order Forms

Do Not Cash

To be posted and used by retail window employees. As directed, destroy previous notices. All interim notices should be destroyed when the numbers listed appear in the *Postal Bulletin*.

671,819,086	686,794,382
676,612,640	686,794,426
677,891,039	686,794,427
678,282,493	686,794,431
678,916,031	687,262,502
679,552,215	687,262,503
679,694,334	687,262,525
679,751,983	687,262,526
679,800,207	687,287,578
681,130,536	687,287,581
681,844,376	687,287,582
683,594,542	694,063,898
684,683,610	694,063,899
686,619,878	694,063,980
686,619,886	701,321,725
686,619,887	

— Postal Inspection Service, 5-3-01

800 Number Available to Verify Canadian Money Orders

The Canada Post Corporation is now providing an 800 number that cashing agents can call to verify the validity of Canadian Postal Money Orders. The number is 1-800-563-0444.

This 800 number is printed on the back of the Canadian Postal Money Orders.

— Postal Inspection Service, 5-3-01

International Mail

IMM REVISION

International Mail — International Customized Mail Service

Effective April 30, 2001, *International Mail Manual* (IMM) 297.2 is revised to change the qualifications for International Customized Mail (ICM) service.

This change will be incorporated into both the printed version of IMM Issue 25 and the online version, which can be accessed via Postal Explorer at <http://pe.usps.gov>.

International Mail Manual (IMM)

	*	*	*	*	*
2	Conditions for Mailing				
	*	*	*	*	*
290	Commercial Services				
	*	*	*	*	*

297 International Customized Mail

* * * * *

297.2 Qualifying Mailers

[Revise 297.2 to read as follows:]

To qualify for ICM service, a mailer must tender all of its ICM mail to the Postal Service and must be capable, on an annualized basis, of either:

- a. Tendering at least 1 million pounds of international letter-post mail (excluding Global Priority Mail) to the Postal Service, or paying at least \$2 million in international letter-post postage to the Postal Service.
- b. Tendering at least 600 pieces of international non-letter-post mail (including Global Priority Mail) to the Postal Service, or paying at least \$12,000 in international non-letter-post postage to the Postal Service.

* * * * *

— Marketing, International Business, 5-3-01

IMM REVISION

International Mail — Mailing to Belarus

Effective May 3, 2001, the individual country listing for Belarus in the *International Mail Manual* (IMM) is revised to reflect a prohibition against mailing all types of animal products to Belarus.

We will incorporate these changes into both the printed version of IMM Issue 25 and the online IMM, which can be accessed via Postal Explorer at <http://pe.usps.gov>.

International Mail Manual (IMM)

* * * * *

Country Conditions for Mailing — Belarus

* * * * *

Prohibitions (130)

[Add the following entry to the list of prohibitions:]

The government of Belarus has instituted a temporary ban against the importation of all animal products that are for human or animal consumption. This includes meats, poultry, milk and dairy products, feeds, and other animal byproducts.

* * * * *

— Marketing, International Business, 5-3-01

*IMM REVISION***International Mail — Mailing to Brazil**

Effective May 3, 2001, the individual country listing for Brazil in the *International Mail Manual* (IMM) is revised to reflect a prohibition against mailing commercial shipments of all tobacco and smoking-related products to Brazil.

We will incorporate these changes into both the printed version of IMM Issue 25 and the online IMM, which can be accessed via Postal Explorer at <http://pe.usps.gov>.

International Mail Manual (IMM)

* * * * *

Country Conditions for Mailing — Brazil**Prohibitions (130)**

[Add the following entries to the list of prohibitions:]

- Commercial shipments that contain cigarettes, cigarrillos, cigars, loose and packaged tobacco, pipes, and other smoking devices.
- Commercial samples that promote tobacco products or smoking-related merchandise.

* * * * *

— Marketing, International Business, 5-3-01

*IMM REVISION***International Mail — Mailing to Croatia**

Effective May 3, 2001, the individual country listing for Croatia in the *International Mail Manual* (IMM) is revised to reflect a prohibition against mailing all meat, milk, and dairy products to Croatia.

We will incorporate these changes into both the printed version of IMM Issue 25 and the online IMM, which can be accessed via Postal Explorer at <http://pe.usps.gov>.

International Mail Manual (IMM)

* * * * *

Country Conditions for Mailing — Croatia**Prohibitions (130)**

[Add the following entry under the "Prohibitions" header:]

The Croatian government has instituted a temporary ban against the importation of all meat, milk, and dairy products derived from cows, goats, sheep, pigs, hogs, or other animal species that are susceptible to foot and mouth disease.

* * * * *

— Marketing, International Business, 5-3-01

IMM AND PUBLICATION 51 REVISIONS

International Mail — Mailing Insured Parcels to India

Effective May 3, 2001, the individual country listing for India in the *International Mail Manual* (IMM) is revised to reflect a lowering of the insurance indemnity limit for airmail and economy (surface) Parcel Post packages that are mailed to India.

We will incorporate these changes into both the printed version of IMM Issue 25 and the next printed version of Publication 51, *International Postal Rates and Fees*. We will also incorporate the changes into the online versions of the IMM and Publication 51, both of which can be accessed via Postal Explorer at <http://pe.usps.gov>.

International Mail Manual (IMM)

* * * * *

Country Conditions for Mailing — India

* * * * *

Special Services

* * * * *

[Revise the insurance fee table to reflect a lowering of the maximum indemnity limit to \$2265 as follows:]

Insurance (320)

Available for **Parcel Post** only (see 324.2 for required markings)

Insured Amount Not over	Fee
\$50	\$1.85
\$100	\$2.60
\$200	\$3.60
\$300	\$4.60
\$400	\$5.60
\$500	\$6.60
Add \$1.00 for each add'l \$100 or fraction of insurance coverage.	
\$2265 max.	\$24.60

* * * * *

Publication 51, International Postal Rates and Fees

* * * * *

Country Listing

[Revise the "Parcel Post Insurance Indemnity Limit" column to \$2265, for India, as follows:]

* * * * *

Country	EMS Rate Group	EMS Max. Weight Limit (lb.)	Airmail Parcel Post Rate Group	Economy (Surface) Parcel Post Rate Group	Parcel Post Max. Weight Limit (lb.)	Parcel Post Insurance Indemnity Limit (\$)	Letter-post Rate Group *	GXG Rate Group
India	8	44	9	8	44	2265	5 *	7

* * * * *

IMM AND PUBLICATION 51 REVISIONS

International Mail — Mailing to Macedonia (Republic of)

Effective May 3, 2001, the *International Mail Manual* (IMM) and Publication 51, *International Postal Rates and Fees*, are revised to reflect an increase in the maximum weight limits for Global Express Mail (EMS) items, airmail Parcel Post packages, and economy (surface) Parcel Post packages that are mailed to the Republic of Macedonia.

We will incorporate these changes into both the printed version of IMM Issue 25 and the next printed version of Publication 51, *International Postal Rates and Fees*. We will also incorporate the changes into the online versions of the IMM and Publication 51, both of which can be accessed via Postal Explorer at <http://pe.usps.gov>.

International Mail Manual (IMM)

* * * * *

Country Conditions for Mailing — Macedonia (Republic of)

* * * * *

[Revise the last row of the *Airmail Parcel Post Rates* table as follows:]

For each additional pound or fraction: \$2.90
Weight Limit: 66 lbs.

* * * * *

[Revise the last row of the *Economy Mail Parcel Post Rates* table as follows:]

For each additional pound or fraction: \$1.50
Weight Limit: 66 lbs.

* * * * *

[Revise the last row of the *Global Express Mail (EMS)* table as follows:]

For each additional pound or fraction: \$3.20
Weight Limit: 66 lbs.

* * * * *

Publication 51, *International Postal Rates and Fees*

* * * * *

[Revise the “EMS Max. Weight Limit” column and the “Parcel Post Max. Weight Limit” column for Macedonia, Republic of, as follows:]

* * * * *

Country	EMS Rate Group	EMS Max. Weight Limit (lb.)	Airmail Parcel Post Rate Group	Economy (Surface) Parcel Post Rate Group	Parcel Post Max. Weight Limit (lb.)	Parcel Post Insurance Indemnity Limit (\$)	Letter-post Rate Group *	GXG Rate Group
Macedonia, Republic of	7	66	6	7	66	2200	5	8

* * * * *

Philately

PICTORIAL CANCELLATION

Peanuts Station Pictorial Cancellation (for Second Day Events)

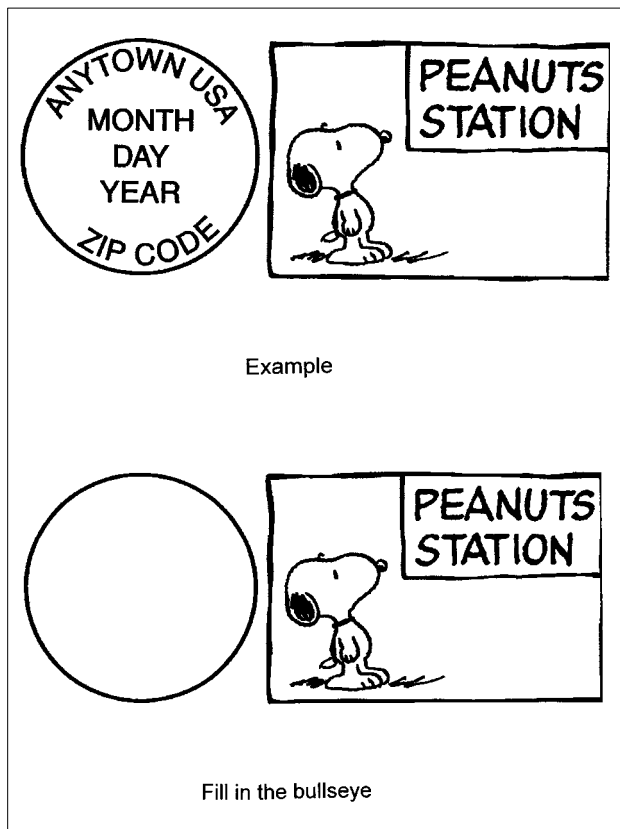

The first day of issue for the *Peanuts* stamp is May 17, 2001, in Santa Rosa, CA 95402. This stamp is being issued nationwide on May 18, 2001. The *Peanuts* pictorial cancellation art shown above was developed exclusively for use for *Peanuts* events starting on the second day of issue, May 18, 2001, and any events thereafter.

This authorized pictorial cancellation may not be altered in any way, except as instructed in the guidelines below. Your Post Office may not use any other reference to the *Peanuts* stamp or *Peanuts* characters.

Guidelines for Finalizing Peanuts Station Pictorial Cancellation Art

To finalize the *Peanuts* station pictorial cancellation art:

1. Insert the actual city and state of the physical location where your event is being held in place of "ANYTOWN USA."

2. Insert the actual date of the event in place of "MONTH, DAY, and YEAR." This date should be May 18, 2001, or a later date.
3. Insert the actual ZIP Code for "ZIP CODE."

Overall dimensions of the pictorial cancellation must not exceed 4 inches horizontally and 2 inches vertically.

Guidelines for Approval of Pictorial Cancellations

1. As a reminder, the Postal Service must endeavor to make all unusual postmarking widely known to collectors through advance national publicity to avoid such postmarks being available only to small groups of people. Therefore, all pictorial cancellations for local events, including *Peanuts*, must be reported to Stamp Development on the *Pictorial Cancellation Announcement* form (page 39 of Handbook PO-230, *Pictorial Cancellations*) so that national publicity may be arranged.
2. Send your art work immediately to:

PICTORIAL CANCELLATIONS
475 L'ENFANT PLZ SW RM 5610
WASHINGTON DC 20260-2437
3. Because of time limitations, you may also fax your artwork on the *Pictorial Cancellation Announcement* form to 202-268-2714. The form is included on page 39 of this *Postal Bulletin* for your convenience. Please paste or tape the pictorial cancellation to that form. Do not fax as a separate attachment.
4. Have a hand cancellation stamp made that uses your city, state, and ZIP Code. The date on your cancellation should be May 18, 2001, or later.
5. Participating Post Offices must honor mail-back service for 30 days following the event.

— Stamp Services,
Public Affairs and Communications, 5-3-01

This page intentionally left blank



Pictorial Cancellation Announcement

<p>Complete this announcement and forward it to your District Manager who, after approval, should then send it to:</p> <p>PICTORIAL CANCELLATIONS STAMP SERVICES US POSTAL SERVICE 475 L'ENFANT PLZ SW RM 5610 WASHINGTON DC 20260-2437</p>	<p>Paste or tape pictorial cancellation copy here. (Camera ready or reproducible) No larger than 4" horizontal x 2" vertical. (The dimensions of this box) Do not send image on a separate sheet.</p>
---	---

Send in all pictorial announcements for approval and publication, even if very close to announcement date. Pictorial announcements will be nationally publicized within 30 days of the event. If the announcements are late in arriving, they may be extended for 30 days.

Postal Service Contact (name, address, phone)	
Station Date(s)	
Sponsor	
Station Name	
Complete Street Address or PO Box Number	
City/State/ZIP+4	

Mail Cancellation Requests to:

Station Name	
Addressee Name (usually " Postmaster ")	
Complete Street Address or PO Box 9998	
City/State/ZIP+4	

CUT ALONG DOTTED LINE



This page intentionally left blank

Pictorial Cancellations Announcement

As a community service, the Postal Service offers pictorial cancellations to commemorate local events celebrated in communities throughout the nation. A list of events for which pictorial cancellations are authorized appears below. If available, the sponsor of the pictorial cancellation appears in italics under the date. Also provided, as space permits, are illustrations of those cancellations that were reproducible and available at press time.

People attending these local events may obtain the cancellation in person at the temporary post office station established there. Those who cannot attend the event, but who wish to obtain the cancellation, may submit a mail order request. Pictorial cancellations are available only for the dates indicated, and *requests must be postmarked no later than 30 days following the requested pictorial cancellation date.*

All requests must include a stamped envelope or postcard bearing at least the minimum First-Class Mail postage. Items submitted for cancellation may not include

postage issued after the date of the requested cancellation. Such items will be returned unserved.

Customers wishing to obtain a cancellation should affix stamps to any envelope or postcard of their choice, address the envelope or postcard to themselves or others, insert a card of postcard thickness in envelopes for sturdiness, and tuck in the flap. Place the envelope or postcard in a larger envelope and address it to: PICTORIAL CANCELLATIONS, followed by the NAME OF THE STATION, ADDRESS, CITY, STATE, ZIP + 4 CODE, exactly as listed below (using all capitals and no punctuation, except the hyphen in the ZIP + 4 code).

Customers can also send stamped envelopes and postcards without addresses for cancellation, as long as they supply a larger envelope with adequate postage and their return address. After applying the pictorial cancellation, the Postal Service returns the items (with or without addresses) under addressed protective cover.

	<p>INDIANA TOWNSHIP 5TH ANNUAL YOUTH DAY STA Saturday, May 19th, 2001 Emmerling Community Park RURAL RIDGE, PA 15075</p>	<p>May 19, 2001 <i>Indiana TWP</i> 5TH ANNUAL YOUTH DAY STATION POSTMASTER PO BOX 9998 RURAL RIDGE PA 15075-9998</p>
	<p>INDIANA TOWNSHIP 5TH ANNUAL YOUTH DAY STA Saturday, May 19th, 2001 Emmerling Community Park INDIANOLA, PA 15051</p>	<p>5TH ANNUAL YOUTH DAY STATION POSTMASTER PO BOX 9998 INDIANOLA PA 15051-9998</p>

	<p>April 6, 2001 <i>Boy Scouts of America</i> W2A SECTION CONCLAVE STATION POSTMASTER 125 E 100 N HEBER CITY UT 84032-9998</p>
--	--

	<p>April 13, 2001 FIRST ANNUAL TRAILHEAD TRAINING STATION POSTMASTER 955 E 100 N PAYSON UT 84651-9998</p>
--	--

	<p>April 12, 2001 100 YEARS ANNIVERSARY STATION POSTMASTER PO BOX 9998 TRENTONIA NM 88439-9998</p>
--	---

	<p>April 14, 2001 <i>City of Claflin</i> JACKIE STILES HOMETOWN STATION POSTMASTER PO BOX 9998 CLAFLIN KS 67525-9998</p>
--	--



April 17, 2001
 SESQUICENTENNIAL STATION
 POSTMASTER
 124 PLAZA NW
 SOCORRO NM 87801-4566



VFW Post 4372 & Aux.
 Diabetes Awareness Education Station
 Odessa, TX 79762
 April 28, 2001

April 28, 2001
 DIABETES AWARENESS
 STATION
 POSTMASTER
 4551 E 52ND ST
 ODESSA TX 79762-9998

"Join us in the fight to find a cure"

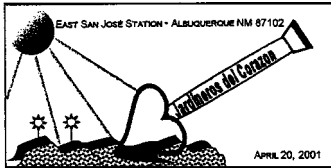

April 20, 2001
 Earth Day Committee
 EAST SAN JOSE STATION
 POSTMASTER
 PO BOX 9998
 ALBUQUERQUE NM
 87102-9998



OPENING DAY
 APRIL 29th, 2001
 BEAR
 MOUNTAIN
 MERRY-GO-ROUND
 BEAR MTN STATION
 BEAR MOUNTAIN, NY 10911

April 29, 2001
 BEAR MOUNTAIN
 MERRY-GO-ROUND STATION
 POSTMASTER
 PO BOX 9998
 BEAR MOUNTAIN NY
 10911-9998



April 20, 2001
 Hershey Post Office
 BIG SKY COUNTRY STATION
 POSTMASTER
 PO BOX 9998
 HERSHEY PA 17033-9998



April 30, 2001
 Boy Scouts
 SCOUT SPIRIT STATION
 POSTMASTER
 201 HIGH ST NE
 WARREN OH 44481-9998



April 21, 2001
 Loyalty
 Dedication
 Weaponsmasters
 True Believers
 JACKASS MAILRUN STATION
 POSTMASTER
 65 W MILL AVE
 PORTERVILLE CA 93257-9998

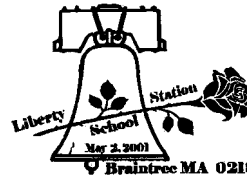

May 2, 2001
 Braintree Historic Society
 LIBERTY SCHOOL STATION
 POSTMASTER
 25 DORCHESTER AVE RM 4009
 BOSTON MA 02205-9600



April 26, 2001
 Diversity Office
 BRING YOUR DAUGHTER TO
 WORK STATION
 POSTMASTER
 DORCHESTER AVE RM 4009
 BOSTON MA 02205-9600



May 3, 2001
 New England Artists Trust
 NEW ENGLAND ARTISTS
 TRUST - CONGRESS 6
 STATION
 POSTMASTER
 22 CENTRAL STREET
 WOODSTOCK VT 05091-9998



April 28, 2001
 CELEBRATION OF LIGHTS
 STATION
 POSTMASTER
 10410 PERRIN BEITEL RD
 SAN ANTONIO TX 78284-9998

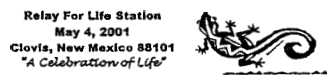

May 4, 2001
 RELAY FOR LIFE STATION
 POSTMASTER
 1224 WEST 21ST ST
 CLOVIS NM 88101-4199



April 28, 2001
 Conestoga District, Cradle of
 Liberty Council, Boy Scouts of
 America
 CAMPOREE STATION
 POSTMASTER
 PO BOX 9998
 GREEN LANE PA 18054-9998



May 5, 2001
 ROSWELL OLD TIMERS
 BALLOON RALLY STATION
 POSTMASTER
 415 N PENNSYLVANIA
 ROSWELL NM 88201-9998

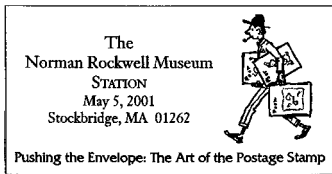

May 5, 2001
The Norman Rockwell Museum
THE NORMAN ROCKWELL
MUSEUM STATION
POSTMASTER
1 ELM ST
STOCKBRIDGE MA 01262-9998



May 9, 2001
SMOKEY'S LIBRARY STATION
POSTMASTER
226 SMOKEY BEAR BLVD
CAPITAN NM 88316-9998



May 5, 2001
Prague Kolache Festival
Association
KOLACHE FESTIVAL STATION
POSTMASTER
901 A AVE
PRAGUE OK 74864-9998



May 10, 2001
FIND A CURE STATION
POSTMASTER
519 POMPTON AVE
CEDAR GROVE NJ 07009-9998



May 5, 2001
Onyx Historical Society
ANNIVERSARY STATION
POSTMASTER
PO BOX 9998
ONYX CA 93255-9998

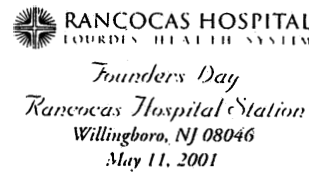

May 11, 2001
Rancocas Hospital
FOUNDERS DAY RANCOCAS
HOSPITAL STATION
POSTMASTER
16 SALEM RD
WILLINGBORO NJ 08046-9998

Alan B. Shepard, Jr. Station
☆☆☆☆☆☆
40th Anniversary Flight Into Space
May 5, 2001
Renaming of the Derry Post Office to
Alan B. Shepard, Jr. Post Office Building
Derry NH 03038

May 5, 2001
Alan B. Shepard Jr. Memorial
Committee
ALAN B. SHEPARD, JR.
STATION
LUCIE RICHER, MARKETING
955 GOFF FALLS ROAD
MANCHESTER NH 03103-9996

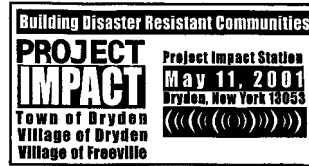

May 11, 2001
Town of Dryden and Freeville,
New York
PROJECT IMPACT STATION
POSTMASTER
27 WEST MAIN ST
DRYDEN NY 13053-9998



Walter A Dudek Memorial Field

May 5, 2001
Walter A Dudek Station
831 Riverside Dr
North Grosvenordale, CT
06255-9998

May 5, 2001
Thompson Recreation
Commission
WALTER A DUDEK STATION
POSTMASTER
831 RIVERSIDE DR
N GROSVENORDALE CT
06255-9998



May 11-20, 2001
Downtown Collinsville Committee
HISTORIC NATIONAL ROAD
SPRING FESTIVAL U.S. ROUTE
40 STATION
POSTMASTER
130 S CENTER
COLLINSVILLE IL 62234-9998

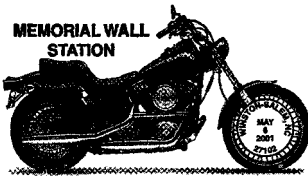

May 6, 2001
MEMORIAL WALL STATION
SUPERVISOR, CUSTOMER
SERVICES
PO BOX 27102
WINSTON SALEM NC
27102-9998



May 12, 2001
Sharon Springs Chamber of
Commerce
RATTLESNAKE ROUNDUP
STATION
POSTMASTER
PO BOX 9998
SHARON SPRINGS KS
67758-9998

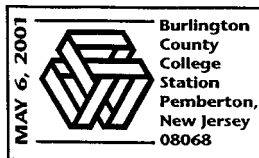

May 6, 2001
Burlington County College
BURLINGTON COUNTY
COLLEGE STATION
POSTMASTER
73 ELIZABETH ST
PEMBERTON NJ 08068-9998

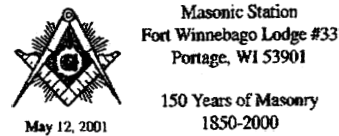

May 12, 2001
Masonic Lodge #33
MASONIC STATION
POSTMASTER
PO BOX 9998
PORTAGE WI 53901-9998



May 13-19, 2001
 Downtown Collinsville Committee
 NATIONAL HISTORIC PRESERVATION WEEK
 DOWNTOWN COLLINSVILLE STATION
 POSTMASTER
 130 S CENTER
 COLLINSVILLE IL 62234-9998



MAY 19, 2001
RELAY FOR LIFE STATION
PARKERSBURG WV 26101
 Fit as a Fiddle, TM

May 18-19, 2001
 American Cancer Society
 RELAY FOR LIFE STATION
 POSTMASTER
 1050 MARKET ST
 PARKERSBURG WV
 26101-9994



May 14, 2001
 OCEAN PINES BRANCH GRAND OPENING STATION
 POSTMASTER
 11115 LAKE VIEW LN
 OCEAN PINES, MD 21811-9998



May 18-20, 2001
 Appalachian Trail Days Committee
 APPALACHIAN TRAIL DAYS STATION
 POSTMASTER
 211 N REYNOLDS ST
 DAMASCUS VA 24236-9998



May 15, 2001
 The Boston Public Library
 THE ABBEY ROOM STATION
 POSTMASTER
 25 DORCHESTER AVE RM 4009
 BOSTON MA 02205-9600



May 18-20, 2001
 City of Sacramento, Kentucky
 BATTLE OF SACRAMENTO STATION
 POSTMASTER
 PO BOX 9998
 SACRAMENTO KY 42372-9998

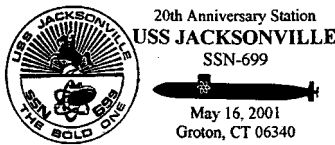

May 16, 2001
 USS JACKSONVILLE 20TH ANNIVERSARY STATION
 POSTMASTER
 100 PLAZA COURT
 GROTON CN 06340-9998



May 18-20, 2001
 ROMPEX
 ROMPEX STATION
 POSTMASTER
 951 20TH ST
 DENVER CO 80202-9998



May 17-17, 2001
 Postal Inspection Service and International Association of Financial Crimes Investigators
 SOUTH CENTRAL SECURITY STATION
 POSTMASTER
 PO BOX 9998
 GRANTVILLE PA 17028-9998

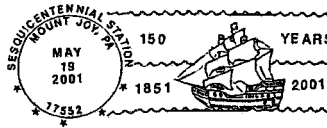

May 19, 2001
 SESQUICENTENNIAL STATION
 POSTMASTER
 1 E MAIN ST
 MT. JOY PA 17552-9998

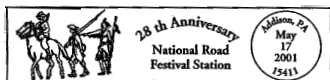

May 17-20, 2001
 NATIONAL ROAD FESTIVAL STATION
 POSTMASTER
 PO BOX 9998
 ADDISON PA 15411-9998



May 19, 2001
 Avoca Village Sales
 AVOCA VILLAGE 3RD ANNUAL LUMBER JACK & JILL STATION
 POSTMASTER
 44 S MAIN ST
 AVOCA NY 14809-9998



May 18, 2001
 CELEBRATION OF THE ARTS STATION
 POSTMASTER
 10000 SLOAN FIELD BLVD
 MIDLAND TX 79711-9998

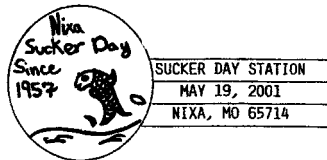

May 19, 2001
 Sucker Day Committee
 SUCKER DAY STATION
 POSTMASTER
 PO BOX 9998
 NIXA MO 65714-9998



May 19, 2001
CENTENNIAL CELEBRATION
STATION
GRANITE QUARRY NC 28072
 PROUD PAST, VIBRANT PRESENT, PROGRESSIVE FUTURE

May 19, 2001
 Town of Granite Quarry NC
 CENTENNIAL CELEBRATION
 STATION
 POSTMASTER
 222 EAST BANK ST
 GRANITE QUARRY NC
 28072-9998



May 19, 2001
 New Image QWL/EI Workteam
 UNION CANAL TUNNEL
 STATION
 POSTMASTER
 PO BOX 9998
 LEBANON PA 17042-9998



Friends of the Library
LAWN SALE STATION
May 19, 2001
Kingsville Public Library
 Kingsville OH 44048

May 19, 2001
 Kingsville Public Library
 LAWN SALE STATION
 POSTMASTER
 3110 W MAIN ST
 KINGSVILLE OH 44048-9998



May 19, 2001
 JEROME HOME TOUR STATION
 POSTMASTER
 PO BOX 9998
 JEROME AZ 86331-9998

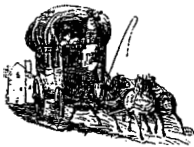

Mount Washington Tavern Station

May 19, 2001
 Fort Necessity National Battlefield
 MT. WASHINGTON TAVERN
 STATION
 POSTMASTER
 ROUTE 381
 FARMINGTON PA 15437-9998



May 19, 2001
 PREAKNESS STATION
 MANAGER MOWS
 900 EAST FAYETTE ST
 BALTIMORE MD 21233-5177

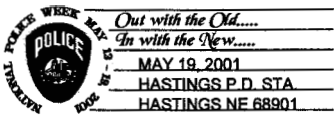

Out with the Old....
In with the New....
MAY 19, 2001
HASTINGS P.D. STA
HASTINGS NE 68901

May 19, 2001
 Hastings Police Department
 HASTINGS P.D. STATION
 POSTMASTER
 300 N KANSAS AVE
 HASTINGS NE 68901-9998



SCOUTING
CELEBRATION
STATION
HARTFORD
CT 06103
MAY 19, 2001

May 19, 2001
 SCOUTING CELEBRATION
 STATION
 POSTMASTER
 80 STATEHOUSE SQUARE
 HARTFORD CT 06103-9998

7th Annual Ice Cream Run for Kids Sake



May 19, 2001
 Ice Cream Run for Kid's Sake
 Committee
 ICE CREAM RUN STATION
 POSTMASTER
 PO BOX 9998
 HAMDEN NY 13782-9998



May 19, 2001
 OLD TOWN WARRENTON
 SPRING FESTIVAL STATION
 PETER JACOBSON, OIC
 53 MAIN ST
 WARRENTON VA 20186-9998



May 19, 2001
 The Chester Foundation
 CHESTER STATION
 POSTMASTER
 PO BOX 9998
 CHESTER MA 01011-9998



May 19, 2001
 BLACK AND WHITE DAYS
 STATION
 POSTMASTER
 3 S STATE ST
 RICHMOND UT 84333-9998



May 19, 2001
 South Charleston Convention and
 Visitors Bureau
 ARMED FORCES DAY STATION
 POSTMASTER
 400 D ST
 SOUTH CHARLESTON WV
 25303-9998



May 19, 2001
 USPS
 DEDICATION STATION
 POSTMASTER
 PO BOX 9998
 GREER AZ 85927-9998



OSCODA COUNTY STATION
MAY 19, 2001
MIO, MI 48647

May 19, 2001
Kirtland Community College
OSCODA COUNTY STATION
POSTMASTER
PO BOX 9998
MIO MI 48647-9998



May 21, 2001
U.S. Mint/Uncover Corp.
PROVIDENCE STATION
POSTMASTER
1 CORLISS ST
PROVIDENCE RI 02904-9998



CLINTON COUNTY
RELAY FOR LIFE
STATION
MAY 19, 2001
LOCK HAVEN, PA 17745

May 19, 2001
American Cancer Society
RELAY FOR LIFE STATION
POSTMASTER
PO BOX 9998
MILL HALL PA 17751-9998



Tabernacle Township
1901 - 2001
A Century of Caring
May 21, 2001

May 21-25, 2001
Township of Tabernacle,
Burlington County, New Jersey
CENTENNIAL STATION
POSTMASTER
1813 ROUTE 206N
VINCENTOWN NJ 08088-9998



Albert Gallatin
NATIONAL ROAD FESTIVAL STATION
Brownsville, Pennsylvania 15417
MAY 19, 2001

May 19-20, 2001
Brownsville Area Revitalization
Corp.
NATIONAL ROAD FESTIVAL
STATION
POSTMASTER
100 CHARLES ST
BROWNSVILLE PA 15417-9998



May 21-28, 2001
Webster County Woodchoppers
Association
WEBSTER SPRINGS STATION
POSTMASTER
100 BACK FORK ST
WEBSTER SPRINGS WV
26288-9998



COFFEYVILLE STAMP CLUB STATION
COFFEYVILLE, KS. 67337 MAY , 2001

May 19-20, 2001
Coffeyville Stamp Club
COFFEYVILLE STAMP CLUB
STATION
POSTMASTER
232 W 8TH ST
COFFEYVILLE KS 67337-9998



May 23, 2001
Finger Lakes Stamp Club
HONORING VETERANS
STATION
POSTMASTER
300 SOUTH MAIN ST
NEWARK NY 14513-9998

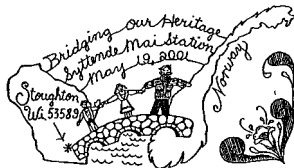

May 19-20, 2001
BRIDGING OUR HERITAGE
"SYTTENDE MAI" STATION
POSTMASTER
PO BOX 9998
STOUGHTON WI 53589-9998



May 23-26, 2001
University of Tennessee
DESTINATION IMAGINATION
STATION
GMF
1237 E WEISGARBER RD
KNOXVILLE TN 37996-9998



May 19-20, 2001
Butler County Philatelic Society
BUTLERPEX STATION
POSTMASTER
345 S MAIN ST
BUTLER PA 16001-9998

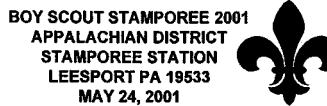

May 24, 2001
Boy Scout Stamporee 2001
STAMPOREE STATION
POSTMASTER
4 E WALL ST
LEESPORT PA 19533-9998



Race to Erase
Station
Breast Cancer Walk

May 20, 2001
Long Beach Breast Cancer
Coalition and Long Beach
Medical Center
RACE TO ERASE STATION
POSTMASTER
PO BOX 9998
LONG BEACH NY 11561-9998



HONORING VETERANS STATION
MAY 25 2001
LAND O LAKES WI 54540

May 25, 2001
VFW Post 8400
HONORING VETERANS
STATION
POSTMASTER
PO BOX 9998
LAND O LAKES WI 54540-9998



May 25, 2001
 Veteran Group
 GOLD STAR MOTHERS
 STATION
 POSTMASTER
 25 DORCHESTER AVE RM 4009
 BOSTON MA 02205-9600

USS KETE SS-369 Station
 Sub Vets of WWII Memorial Dedication



May 26, 2001
 New Castle, DE 19720-9998

May 26, 2001
 Universal Ship Cancellation
 Society
 USS KETE SS-369 STATION
 POSTMASTER
 501 DELAWARE ST
 NEW CASTLE DE 19720-9998



May 25-27, 2001
 Kremlin Centennial & Western
 Heritage Celebration
 KREMLIN CENTENNIAL
 STATION
 POSTMASTER
 PO BOX 9998
 KREMLIN OK 73753-9998



GIVE ME MY "LITTLE VICTORIES"
 May 26, 2001
 Harvard Station
 East Branch, NY 13756
 Players' 5th year Anniversary

May 26, 2001
 Little Victory Players
 HARVARD STATION
 POSTMASTER
 PO BOX 9998
 EAST BRANCH NY 13756-9998



LOGAN HILLS FESTIVAL
 STATION
 Zanesfield, Ohio 43360
 May 25, 2001

May 25-28, 2001
 LOGAN HILLS FESTIVAL
 STATION
 POSTMASTER
 PO BOX 9998
 ZANESFIELD OH 43360-9998



ALAMO, TN 38001
 May 26, 2001

May 26, 2001
 City of Alamo
 FREEDOM CELEBRATION
 STATION
 POSTMASTER
 80 E PARK ST
 ALAMO TN 38001-9998



May 26, 2001
 Montrose, MO 64770

Doan Hotel, 1900
 "Past Glories - Future Dreams"

May 26, 2001
 Montrose Festival Committee
 MONTROSE FESTIVAL STATION
 POSTMASTER
 307 ILLINOIS AVE
 MONTROSE MO 64770-9998



May 26-27, 2001
 Dayton Chamber of Commerce
 LUCERA PARSONS STATION
 POSTMASTER
 PO BOX 9998
 DAYTON NV 89403-9998

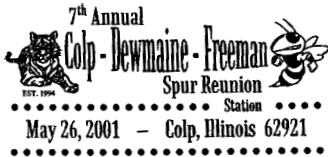

May 26, 2001 - Colp, Illinois 62921

May 26, 2001
 Spur Reunion Committee
 7TH ANNUAL COLP, DEWMAINE
 FREEMAN SPUR REUNION
 STATION
 POSTMASTER
 PO BOX 9998
 COLP IL 62921-9998



MAY 26, 2001

May 26-27, 2001
 Fossil Festival Committee
 FOSSIL FESTIVAL STATION
 POSTMASTER
 186 N 5TH ST
 AURORA NC 27806-9998

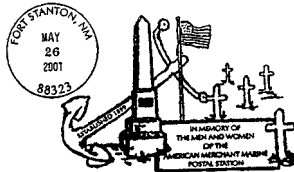

May 26, 2001
 AMERICAN MERCHANT
 MARINE POSTAL STATION
 POSTMASTER
 PO BOX 9998
 FORT STANTON NM
 88323-9997



ST. CLAIR SHORES, MI 48080
 MAY 27, 2001

May 27, 2001
 St. Clair Shores Parade Council
 MEMORIAL DAY PARADE
 STATION
 POSTMASTER
 23125 GREATER MACK AVE
 ST. CLAIR SHORES MI
 48080-9998



May 26, 2001
 CRAIG, AK 99921

May 26, 2001
 Chamber of Commerce
 MARATHON STATION
 POSTMASTER
 PO BOX 9998
 CRAIG AK 99921-9998



May 27, 2001 ★ Dieterich, IL 62424

May 27, 2001
 Veteran's Committee
 VETERAN'S MEMORIAL
 DEDICATION STATION
 POSTMASTER
 PO BOX 9998
 DIETERICH IL 62424-9998

New Hartford, New York 13413
Centennial Station

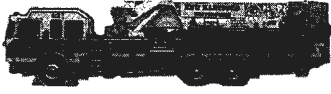

May 28, 2001

May 28, 2001
New Hartford Fire Department
CENTENNIAL STATION
POSTMASTER
PO BOX 9998
NEW HARTFORD NY
13413-9998



GOLETA DEPOT
CENTENNIAL
STATION
GOLETA, CA 93117
MAY 30, 2001

May 30, 2001
South Coast Railroad Museum
GOLETA DEPOT CENTENNIAL
STATION
POSTMASTER
836 ANACAPA ST
SANTA BARBARA CA
93102-9998



VETERANS
MEMORIAL STATION
MAY 28 2001
BERNHARDS BAY,
NY 13028

May 28, 2001
Trach-Auringer VFW Post 7325
VETERANS MEMORIAL
STATION
POSTMASTER
PO BOX 9998
BERNHARDS BAY NY
13028-9998

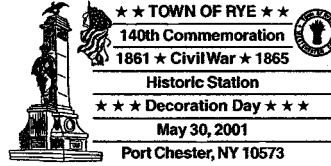

★★ TOWN OF RYE ★★
140th Commemoration
1861 ★ Civil War ★ 1865
Historic Station
★★★ Decoration Day ★★★
May 30, 2001
Port Chester, NY 10573

May 30, 2001
Town of Rye, New York
HISTORIC STATION
POSTMASTER
PO BOX 9998
PORT CHESTER NY
10573-9998



BOLDER•BOULDER
BOLDER BOULDER STATION
MAY 28, 2001 • BOULDER, COLORADO 80309

May 28, 2001
Bolder Boulder
BOLDER BOULDER STATION
POSTMASTER
1905 15TH ST
BOULDER CO 80302-9998

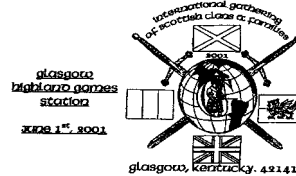

glasgow
highland games
station
MAY 30, 2001
glasgow, kentucky. 42141

May 30-June 3, 2001
Glasgow Highland Games, Inc.
GLASGOW HIGHLAND GAMES
STATION
POSTMASTER
PO BOX 9998
GLASGOW KY 42141-9998



1796 - 2001
The Monroe Women
200 years of History



May 28, 2001
Eaton's Historical Group
EATON STATION
POSTMASTER
PO BOX 9998
EATON NY 13334-9998



May 31, 2001
Mass Gathering Station
Worcester, MA 01613

May 31-June 2, 2001
Harley Owners Group
MASS GATHERING STATION
POSTMASTER
4 E CENTRAL ST
WORCESTER MA 01613-9998



Sesquicentennial Station
Campbellsburg In 47108-9998

May 29-June 3, 2001
City of Campbellsburg, Indiana
SESQUICENTENNIAL STATION
POSTMASTER
PO BOX 9998
CAMPBELLSBURG IN
47108-9998

— Stamp Services,
Public Affairs and Communications, 5-3-01

Special Cancellation Die Hubs

Postmasters and plant managers who have any of the special cancellation die hubs listed below may use them for the periods designated. At the end of the period, these die

hubs must be withdrawn and stored. Postmasters and plant managers who do not have these special die hubs may not request them from the sponsors.

Cancellation	Period of Use
National Carih Asthma Week	April 1-May 6
Only You Can Prevent Forest Fires	April 1-Oct. 31
National Salvation Army Week, 4 th Week in May	May 1-May 31
Support Research for "NF," Neurofibromatosis	May 1-May 31
Support Your Mental Health Association	May 1-May 31
National Flag Day, June 14, Pause for the Pledge	May 1-June 14
Goodwill Industries — Our Business Works So People Can	May 1-June 30
Support National Historic Preservation Week	May 9-May 15
National Transportation Week	May 14-May 20
Fight Disease, Support City of Hope Pilot Medical Center	May 15-June 15
Defeat Muscular Dystrophy, Support MDAA	May 15-June 17
Conquer Multiple Sclerosis	May 17-June 17
Conquer Cystic Fibrosis	Sept. 1-Sept. 30
Peace Corps Anniversary, Making a Difference	Sept. 1-Oct. 31
Employ People With Disabilities	Sept. 1-Nov. 30
Give to the United Way	Sept. 15-Nov. 15
Learn About Lupus, October Is Lupus Awareness Month	Oct. 1-Oct. 31
Radon Action Week, Protect Your Family, Test Your Home	Oct. 1-Oct. 31
Support Infection Control Week	Oct. 1-Nov. 30
Help Retarded Children	Nov. 1-Nov. 30
Military Families Recognition Day	Nov. 1-Nov. 30
National Adoption Month	Nov. 1-Nov. 30
National Philanthropy Day, Love of Humankind	Nov. 1-Nov. 30
Use Christmas Seals, Support Your Lung Association	Nov. 8-Dec. 31
Support American Education Week	Nov. 10-Nov. 30
Autistic Children, Hope Through Research and Education	Dec. 1-Dec. 31

Post Offices

Post Office Changes

Old/ New	Finance No.	ZIP Code	State	P.O. Name	County/ Parish	Station/Branch/ Unit	Unit Type	Effective Date	Comments
Old	03-6364	85040	AZ	Phoenix	Maricopa	South Mountain	Classified Station	07/01/2001	Establish a new ZIP Code for a delivery area. Use Phoenix AZ 85042 as last line of address for a portion of the deliveries previously in ZIP Code 85040.
New	03-6364	85042	AZ	Phoenix	Maricopa	South Mountain	Classified Station	07/01/2001	
Old	05-0222	92803	CA	Anaheim	Orange	Main Office	Post Office	07/01/2001	Establish a new ZIP Code for a delivery area. Use Anaheim CA 92809 as last line of address for a portion of the deliveries previously in ZIP Code 92803.
New	05-0222	92809	CA	Anaheim	Orange	Anaheim Hills East	Classified Station	07/01/2001	
Old	05-6950	91350	CA	Santa Clarita	Los Angeles	Main Office	Post Office	07/01/2001	Establish a new ZIP Code for a delivery area. Use Santa Clarita CA 91390 as last line of address for a portion of the deliveries previously in ZIP Code 91350.
New	05-6950	91390	CA	Santa Clarita	Los Angeles	Main Office	Post Office	07/01/2001	
Old	05-6950	91351	CA	Santa Clarita	Los Angeles	Golden Valley	Classified Station	07/01/2001	Establish a new ZIP Code for a delivery area. Use Santa Clarita CA 91387 as last line of address for a portion of the deliveries previously in ZIP Code 91351.
New	05-6950	91387	CA	Santa Clarita	Los Angeles	Golden Valley	Classified Station	07/01/2001	
Old	11-7845	32351	FL	Quincy	Gadsden	Main Office	Post Office	07/01/2001	Realign ZIP Code boundaries. Use Quincy FL 32352 as last line of address for the deliveries previously in ZIP Code 32351. This amends PB 22047.
New	11-7845	32352	FL	Quincy	Gadsden	Main Office	Post Office	07/01/2001	
Old	11-7845	32352	FL	Quincy	Gadsden	Main Office	Post Office	07/01/2001	This announcement expands the use of ZIP Code 32352 to include delivery. This amends PB 22047.
New	11-7845	32352	FL	Quincy	Gadsden	Main Office	Post Office	07/01/2001	
Old	11-2100	32124	FL	Daytona Beach	Volusia	Main Office	Post Office	07/01/2001	Establish a new ZIP Code for a delivery area. Use Daytona Beach FL 32128 as last line of address for a portion of the deliveries previously in ZIP Code 32124. This amends PB 22047.
New	11-2100	32128	FL	Daytona Beach	Volusia	Port Orange	Classified Branch	07/01/2001	
Old	11-3660	32561	FL	Gulf Breeze	Santa Rosa	Main Office	Post Office	07/01/2001	Establish a new ZIP Code for a delivery area. Use Gulf Breeze FL 32563 as last line of address for a portion of the deliveries previously in ZIP Code 32561.
New	11-3660	32563	FL	Gulf Breeze	Santa Rosa	Main Office	Post Office	07/01/2001	
Old	11-1020	33511	FL	Brandon	Hillsborough	Main Office	Post Office	07/01/2001	Establish a new ZIP Code for Post Office Boxes. Use Brandon FL 33508 as last line of address for the Post Office Boxes at the new Classified Station.
New	11-1020	33508	FL	Brandon	Hillsborough	Bloomingtondale	Classified Branch	07/01/2001	

Old/ New	Finance No.	ZIP Code	State	P.O. Name	County/ Parish	Station/Branch/ Unit	Unit Type	Effective Date	Comments
Old	38-3504	27536	NC	Henderson	Vance	Main Office	Post Office	07/01/2001	Establish a new ZIP Code for a delivery area. Use Henderson NC 27537 as last line of address for a portion of the deliveries previously in ZIP Code 27536.
New	38-3504	27537	NC	Henderson	Vance	Main Office	Post Office	07/01/2001	
Old	31-6200	89033	NV	North Las Vegas	Clark	Meadow Mesa	Classified Station	07/01/2001	Establish a new ZIP Code for a delivery area. Use North Las Vegas NV 89084 as last line of address for a portion of the deliveries previously in ZIP Code 89033.
New	31-6200	89084	NV	North Las Vegas	Clark	Meadow Mesa	Classified Station	07/01/2001	
Old	41-3568	18201	PA	Hazleton	Luzerne	Main Office	Post Office	07/01/2001	Establish a new ZIP Code for a delivery area. Use Hazleton PA 18202 as last line of address for a portion of the deliveries previously in ZIP Code 18201.
New	41-3568	18202	PA	Hazleton	Luzerne	Main Office	Post Office	07/01/2001	
Old	47-1944	38018	TN	Cordova	Shelby	Main Office	Post Office	07/01/2001	Establish a new ZIP Code for a delivery area. Use Cordova TN 38016 as last line of address for a portion of the deliveries previously in ZIP Code 38018.
New	47-1944	38016	TN	Cordova	Shelby	Main Office	Post Office	07/01/2001	
Old	48-2270	75240	TX	Dallas	Dallas	Spring Valley	Classified Station	07/01/2001	Establish a new ZIP Code for a delivery area. Use Dallas TX 75254 as last line of address for a portion of the deliveries previously in ZIP Code 75240.
New	48-2270	75254	TX	Dallas	Dallas	Spring Valley	Classified Station	07/01/2001	
Old	51-5880	23113	VA	Midlothian	Chesterfield	Main Office	Post Office	07/01/2001	Establish a new ZIP Code for a delivery area. Use Midlothian VA 23114 as last line of address for a portion of the deliveries previously in ZIP Code 23113.
New	51-5880	23114	VA	Midlothian	Chesterfield	Main Office	Post Office	07/01/2001	

— Address Management, 5-3-01

Postal Employees

POSTMASTERS/INSTALLATION HEADS AT LEVEL 20–26 POST OFFICES

Conducting Annual Safety and Health Inspections

Within the next 30 days, Safety Performance Management at Headquarters is mailing a package to Level 20–26 Post Offices (with less than 100 employees) containing safety and health inspection checklists and instructions for completing an inspection. Postmasters/installation heads (PM/IH) at those offices, or their designees, must complete a safety and health inspection using the checklist within 30 days of receipt of the package. These annual safety and health inspections are required by ELM 824.

Additionally, PM/IH in those offices must ensure that subordinate stations and branches conduct an inspection.

PM/IH must post the inspection and ensure abatement of all deficiencies in accordance with the instructions. They must also certify completion of the inspection to the servicing safety office. PM/IH should contact their servicing safety office if they need technical or programmatic assistance or if they do not receive the package that includes the inspection checklists and instructions.

— Safety Performance Management,
Employee Resource Management, 5-3-01

Safety Alert — Equipment Repair and Replacement

The Postal Service Office of Inspector General (OIG) has conducted an investigation and advised that postal equipment manufactured by the Medcab Division of Pacific Precision Metals contains defects that can be potential safety hazards. The defective equipment consists of steel mail sorting units (109B, 109D, 136B, and 136D) and steel letter-bundle drop units (1577C and 1577D). Medcab supplied the units between October 1997 and July 2000. The manufacturer identification stickers are generally located on the underside of the mail sorting table and on the interior wall of the letter-bundle drop unit.

Adjusting or Repairing Mail Sorting Units Until Replacement

Defects on the *mail sorting units* entail the misalignment of brackets and the inadequate screw attachment of the table legs and case to the table base. The OIG has judged the manufacturing flaws on these units as significant, because the movement of a unit (case and table) could cause the case to fall. Until the units can be replaced, the following interim corrective action and repair is suggested:

- **Assess the current location and stability of the unit. If necessary, relocate it to where it will have minimal exposure to being moved or bumped.**
- **Ensure the case is secured to the tabletop as necessary.**
 - **Drill through case, tabletop, and side curb screw holes that are not aligned. In some cases, new holes and side curb modifications will be needed.**
 - **Insert proper size self-tapping or machine screws. Tighten all screws, being cautious to avoid excessive tightening and stripping of the metal.**

Repairing Letter-Bundle Drop Units or Replacement

The *letter-bundle drop units*, based on OIG findings, may have sharp edges at the letter drop or bundle drop and alignment problems at the bundle-drop door. The following temporary repairs are suggested:

- **File, sand, or protect sharp edges at the letter and bundle drop.**
- **File or sand the frame or edges of the bundle-drop doors to temporarily stop the binding.**

If the sharp edges or binding defects cannot be completely eliminated and satisfactorily finished, a replacement unit must be ordered. Postmasters or managers must order all replacement units from the Topeka Material Distribution Center.

On pages 53–55 are drawings of the equipment with defects noted. Records indicate there are over 1,900 mail sorting units and 5,200 letter-bundle drop units in the field.

Completing the Equipment Repair and Replacement Worksheet Due June 4

A *Safety Alert — Equipment Repair and Replacement Worksheet* on page 57 is provided to document equipment repair and replacement costs for future reimbursement. The responsible facility person must tear out and sign the worksheet to certify that equipment has been inspected and appropriate action has been taken. Send or FAX the worksheet by June 4, 2001, to *both* the OIG and the Safety Performance Management addresses noted at the bottom of the worksheet.

— *Safety Performance Management,
Employee Resource Management, 5-3-01*

PSIN 109B & D
CITY DELIVERY FLAT
PAPER CASE AND TABLE

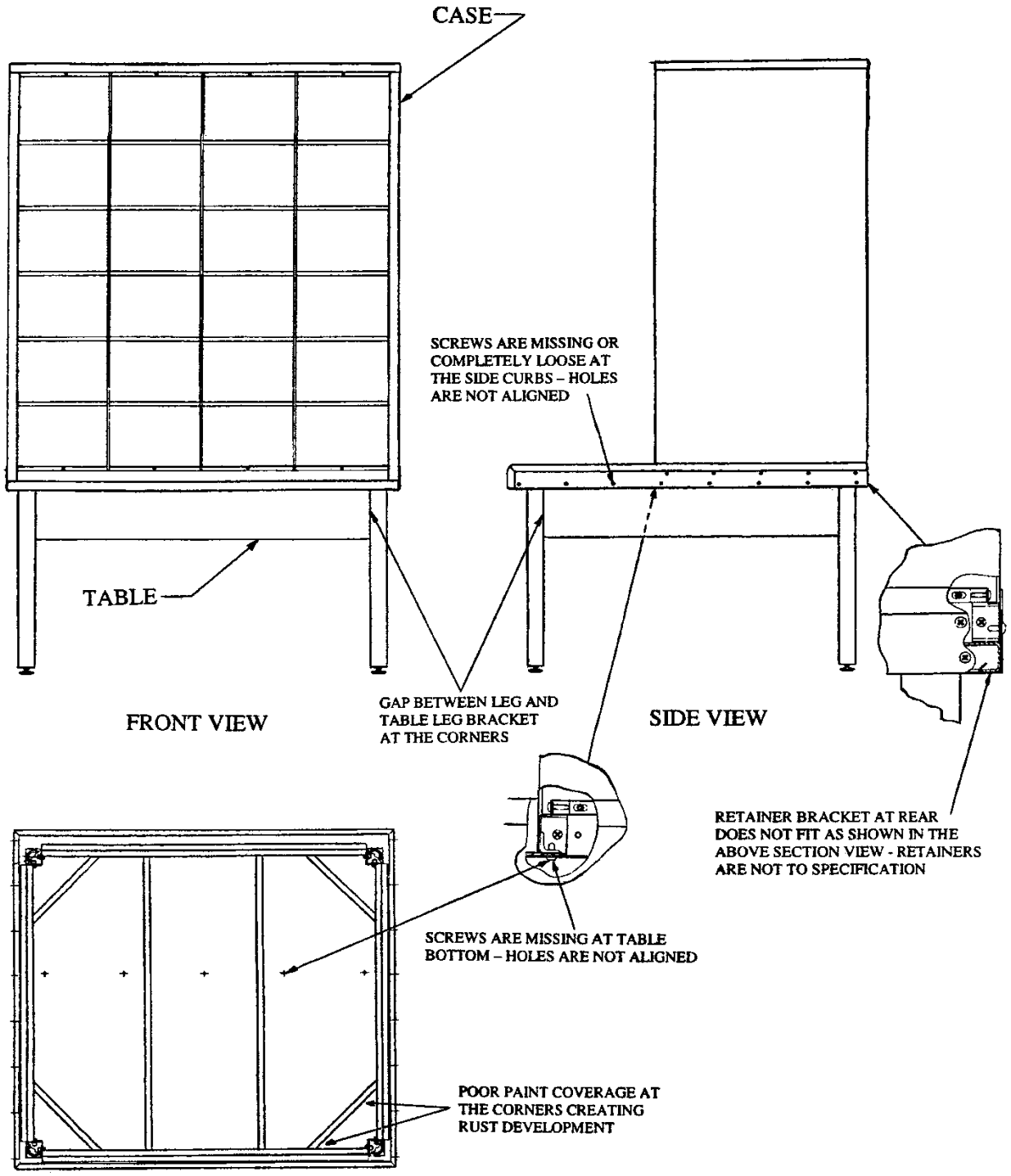

FRONT VIEW

SIDE VIEW

TABLE

CASE

SCREWS ARE MISSING OR COMPLETELY LOOSE AT THE SIDE CURBS - HOLES ARE NOT ALIGNED

GAP BETWEEN LEG AND TABLE LEG BRACKET AT THE CORNERS

RETAINER BRACKET AT REAR DOES NOT FIT AS SHOWN IN THE ABOVE SECTION VIEW - RETAINERS ARE NOT TO SPECIFICATION

SCREWS ARE MISSING AT TABLE BOTTOM - HOLES ARE NOT ALIGNED

POOR PAINT COVERAGE AT THE CORNERS CREATING RUST DEVELOPMENT

TABLE BOTTOM VIEW

PSIN 109B - SHOWN

PSIN 136B & D
CITY DELIVERY FLAT
PAPER CASE AND TABLE

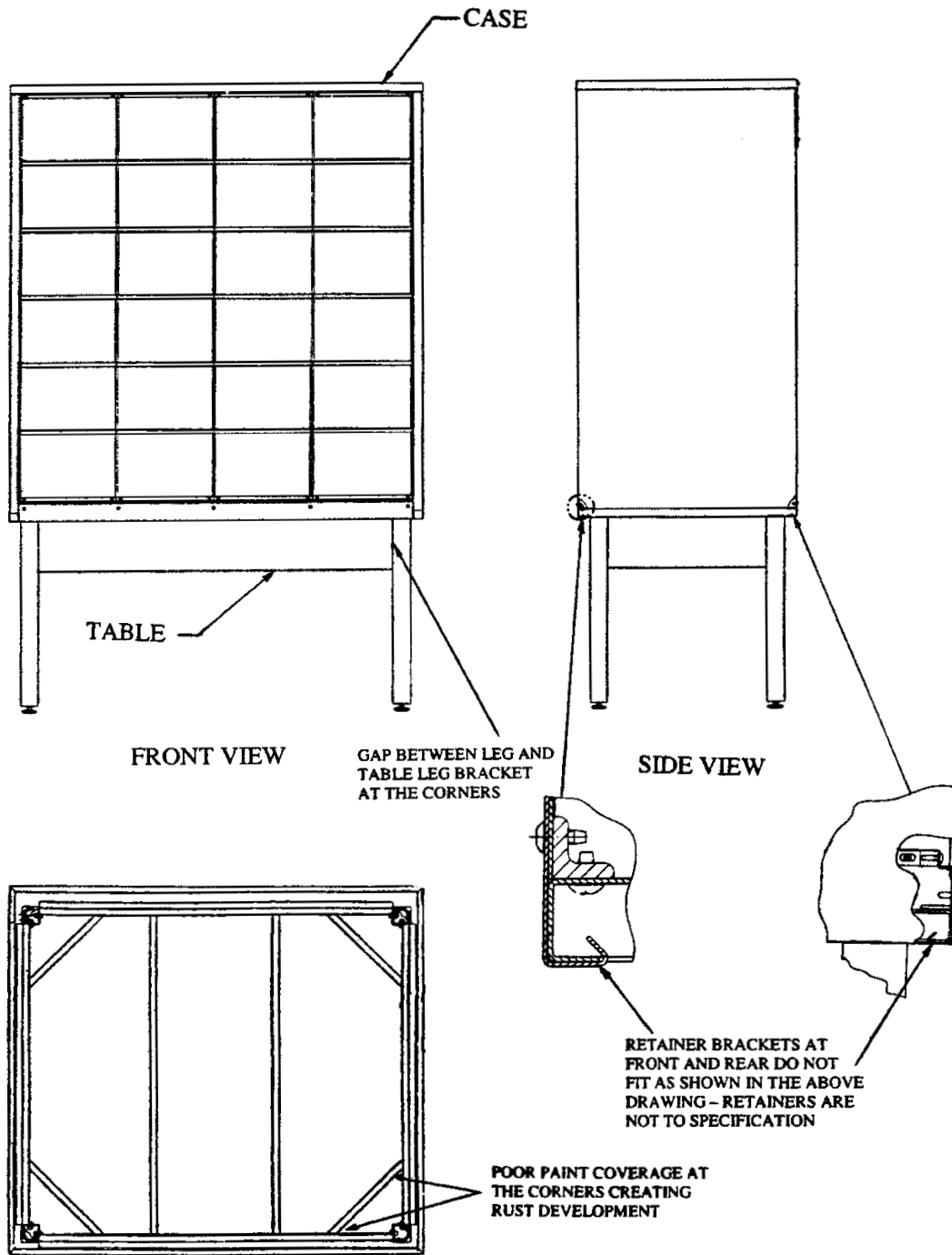

FRONT VIEW

SIDE VIEW

TABLE BOTTOM VIEW

PSIN 136B SHOWN

PSIN 1577C & D
LETTER & BUNDEL
DROP UNIT

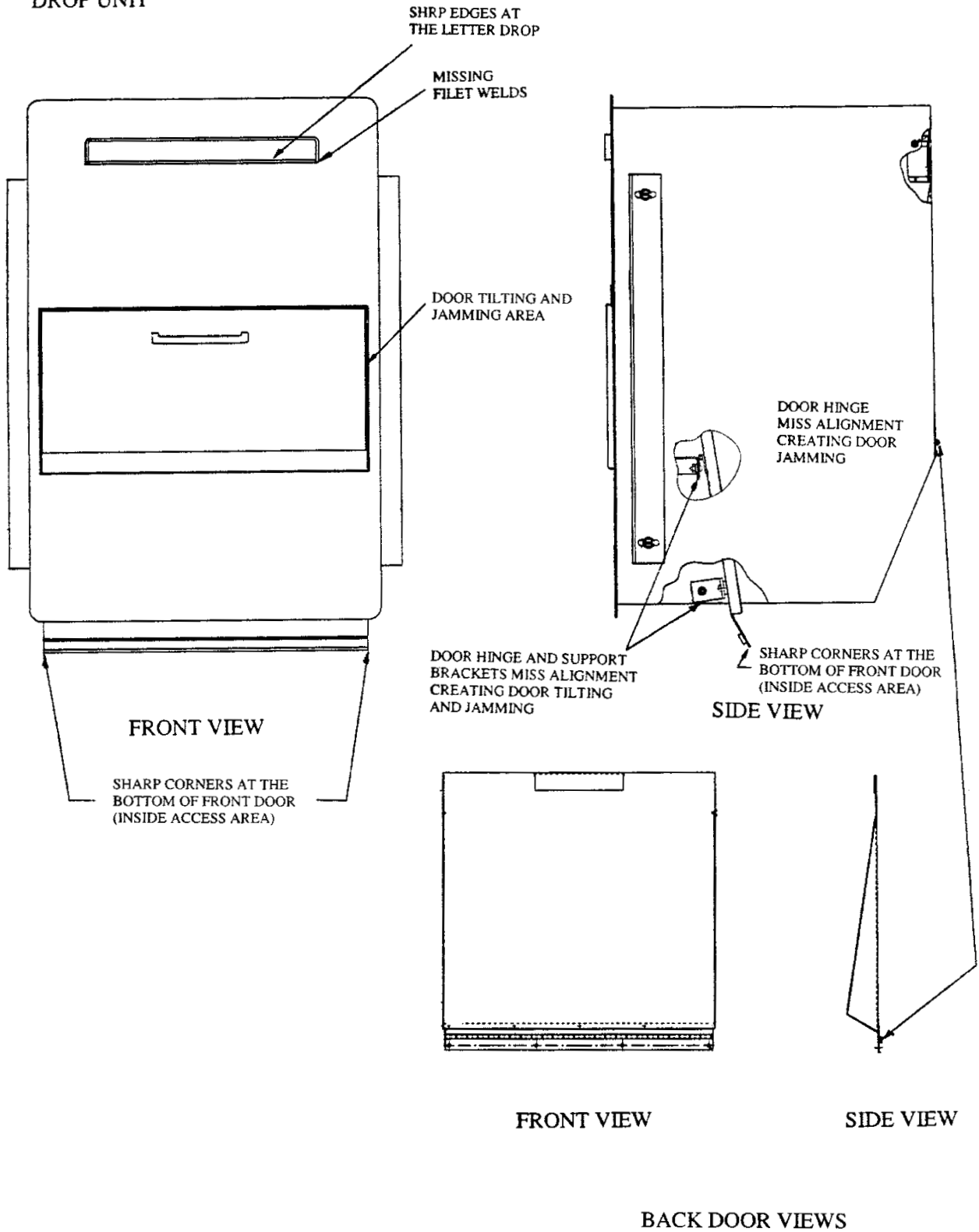

This page intentionally left blank

Safety Alert — Equipment Repair and Replacement Worksheet

This worksheet documents and certifies the costs for repair and replacement of defective equipment: steel Mail Sorting Units (109B, 109D, 136B, and 136D) and steel Letter-Bundle Drop Units (1577C and 1577D) manufactured by Medcab.

Facility: _____
Street Address City State ZIP Code

Responsible Person Providing Certification: _____
Name Title Date

_____ Phone Number

PSIN	# Units	* Cost

Total Cost _____

***Costs for parts, labor, and disposal of existing units and for the purchase, shipment, and labor to install new units. Attach available bills, receipts, and estimates.**

Send or FAX to both of the following by June 4, 2001:

**USPS OFFICE OF INSPECTOR GENERAL
 ATTN DAVID E SERMOS SPECIAL AGENT
 77 WESTPORT PLAZA STE 325
 ST LOUIS MO 63146-3124
 FAX 314-439-6044**

**USPS SAFETY PERFORMANCE MANAGEMENT
 475 L'ENFANT PLAZA SW RM 9801
 WASHINGTON DC 20260-4231
 FAX 202-268-2206**

CUT ALONG DOTTED LINE



This page intentionally left blank

Purchasing and Materials

CORRECTION

FEDSTRIP Address Activity Code Assignment and Maintenance

Correction to validating address in Address Management System for new and changed FEDSTRIPs in "FEDSTRIP Address Activity Code Assignment and Maintenance" (Postal Bulletin 22042, page 79). Corrected text is shown in bold.

The Federal Standard Requisitioning and Issue Procedures (FEDSTRIP) address activity code is used for acquisition of many commonly used products from internal postal organizations (i.e., the Material Distribution Center) and external suppliers such as Boise Cascade Office Products, which has a national strategic partnership with the Postal Service. Incomplete and inaccurate addresses delay the delivery of orders and increase costs to the Postal Service.

FEDSTRIP holders are responsible for ensuring that the FEDSTRIP address, finance number, and budget authorization (B/A) code data are accurate, complete, and maintained in a continuously current manner. The address must meet postal addressing standards as outlined in Publication 28, *Postal Addressing Standards*, and must be able to meet the Coding Accuracy Support System (CASS) certification requirements.

Field Installations

Prior to submitting requests to the district material management specialist for a new FEDSTRIP (or to change the address for an existing FEDSTRIP), field installations must verify that the address is valid in the Address Management System (AMS) Automated Data Collection System (ADCS) by contacting the appropriate district address management specialist.

Headquarters/Headquarters-Related Field Offices

Submit new FEDSTRIP assignments and changes to existing FEDSTRIPs via cc:Mail to Larry A. Browne at Headquarters, providing the following information for each request:

- Finance number.
- Budget authorization code (B/A).
- Complete address to include:
 - (1) Organization name.
 - (2) Street address (include room number).
 - (3) City, state, and ZIP+4.
 - (4) Point of contact name, area code, and telephone number.

Prior to submitting requests, Headquarters and Headquarters-related field offices must validate the street address, room number or suite number, and the ZIP+4. Contact the National Customer Support Center at 800-331-5746, ext. 4438, and validate the address that the FEDSTRIP number is being established under. You must correct your address in AMS for new FEDSTRIP assignments and for any changes that are being made to established FEDSTRIPs. The FEDSTRIP address and the AMS address must be the same before a new FEDSTRIP is assigned or before an established FEDSTRIP can be changed.

Postal Inspection Service Offices

All Postal Inspection Service offices must submit their FEDSTRIP requests as directed by Sylvia G. Parrott, Headquarters, Postal Inspection Service.

Military Post Offices

All military post offices must submit their FEDSTRIP requests as directed by the Military Postal Service Agency.

Retail

What's in Store

POS ONE Message Center

It's historic!

The POS ONE Message Center delivers the right information to the right people at the right time. Launched on April 19, this new and exciting information gateway enables a direct connection daily with front-line retail employees, providing them with the latest information about Postal Service products and services.

Postmaster General William J. Henderson says "it's historic, not only for the Postal Service, but in the world of technology as well." The POS ONE Message Center links more than 36,000 terminals at more than 8,000 retail locations.

As part of the Postal Service's commitment to keep its retail unit employees informed, this powerful tool will be used to provide important, time-sensitive information they need to give Postal Service customers the best service possible.

Global Express Guaranteed Service Guides on the way

*(Look for
May 15
service guide)*

Be on the lookout for Volume 7 of Publication 141, *Global Express Guaranteed Service Guide*, dated May 15, 2001. It will be mailed to about 20,000 retail locations. Accompanying this mailing will be 24" x 36" *Global Express Guaranteed* posters and 3.5" x 8" *Clerk Reference Cards*.

Global Express Guaranteed, the Postal Service's premier international expedited service, celebrated its second birthday on April 19. Although growing quickly, a few retail acceptance opportunities still exist. For example, retail associates should advise customers that service to some remote areas of Mexico is available only on certain delivery days. Likewise, all pieces bound for Canada with a shipping value of \$13.50 and greater must be accepted as nondocument shipments.

What's in Store

Additionally, the value of a documents-only shipment, as claimed on a *Global Express Guaranteed* shipping label, must reflect the reconstruction value of that document only, not the value of the document itself. For example, \$75 may be the cost of replacing a \$450 airline ticket. Hence, the customer will state that the value of the shipment is \$75, not \$450. And, as always, all labels — for both document and nondocument shipments — must contain a stated value of the shipments.

These acceptance opportunities — and all *Global Express Guaranteed* retail acceptance procedures — are featured in the upcoming *Global Express Guaranteed Service Guide*.

Feedback

Send comments and questions to:

WHAT'S IN STORE
US POSTAL SERVICE
1735 N LYNN STREET RM 6042
ARLINGTON VA 22209-6057

What's in Store



Retail Coaches Corner

Welcome to the May Corner!

The Big Picture

What's the goal of the *Retail Coaches Corner*?

The goal of the *Retail Coaches Corner* is to provide timely and relevant information for dissemination to every employee who has responsibilities at the retail counter.

Who is the retail coach?

Many units have retail coaches who have been certified through the Sales and Services Associate Training Course. These employees serve as on-the-job instructors for this program. Many local managers use the coaches' knowledge and experience to assist in delivering other retail information. This may be about new products and services being introduced or a technical change on how to complete a transaction properly using retail equipment.

In addition to their official instructional duties, retail coaches may be utilized to enhance the sales knowledge of all retail employees. If a retail coach is not available or assigned, however, the supervisor or manager must ensure that appropriate information is communicated.

Some units have a certified retail coach and a supervisor available to deliver retail information. They have the benefit of using the experience of the certified retail coach and the support of the supervisor or manager.

Article Contents

The *Postal Bulletin* is a Postal Service publication widely recognized by field employees. Past editions of the *Retail Coaches Corner* have included information on the following:

1-11-01: Rate changes, questions, and reference information.

2-8-01: A review of January's questions, retail calendar, and retail coaches website.

3-8-01: Survey questions regarding the sales skills training program and review of steps of the standard transaction process.

4-5-01: Tax and Express Mail information, value sell defined, survey questions, and response to readers' feedback.

Your comments are welcome

- What kind of information do you need to see in the *Corner*?
- What best practices or success stories can you share to assist other retail units?

Feedback

Write the Retail Coaches Corner via cc:Mail at *Retail Coaches Corner*, or call Hank Heren at 703-292-3774.

What's in Store

your

Retail Calendar

'01
SPRING

May

SUN		MON		TUE	WED	THU	FRI	SAT
				1 Retail Reminder: Don't forget to check the lobby sales bin, remove trash, and restock merchandise	2 Vending Reminder: Refer to the Self Service Intranet Web page for the latest vending news at retail.usps.gov	3 Inform Your Customers that they can generate Mother's Day greeting cards through NetPost™ CardStore available online	4 Retail Reminder: Last day for Districts to input VESS data for AP 8	5 <i>Cinco de Mayo</i>
6 Inform Your Customers that www.postmarkamerica.com * has great merchandise	7 Retail Reminder: Make a Mother's Day card a gift by including a Love FIRSTCLASS PHONECARD®	8 Vending Reminder: Clean your validators regularly — don't wait for failures. Refer to MM0-056 00, Ardac Validator Cleaning Instructions, 6/2/00	9	10 Last day for Priority Mail® service to arrive by Mother's Day*	11 <i>payday</i>	12 Last day for Express Mail® service to arrive on Mother's Day*		
13 Mother's Day	14 Retail Reminder: Make sure you have ordered Item Number 315500, <i>Honoring Veterans</i> , 20-stamp commemorative packet for vending	15	16	17 Vending Reminder: See the Self Service Intranet Web page to learn about the newly released "Validator Cleaning Procedures" CD	18	19 AP 10 begins <i>Armed Forces Day</i>		
20 Did You Know? The first Peanuts® comic strip appeared on October 7, 1950	21 Make sure Holiday Closing door sign is displayed	22 Vending Reminder: Use the PHASE II Information Transfer Units (ITUs) to reprofile <i>all</i> vending equipment validators at servicing	23 Retail Reminder: When customers request Vacation Hold forms, make sure they pack a FIRSTCLASS PHONECARD for their travels	24	25 Inform Your Customers that they can manage their bills online with USPS eBillPay™ at www.usps.com * <i>payday</i>	26 Retail Reminder: Reorder merchandise as necessary and allow 3 weeks for shipments to arrive		
27 Did You Know? On March 30, 1993, Charlie Brown hit the game-winning home run, his first and only one in the history of the comic strip	28 Offices Closed <i>Memorial Day</i>	29	30 Vending Reminder: How many validators did you return to Topeka this month? Did you include your FEDSTRIP number? If not, you will not get proper credit	31 Retail Reminder: Be sure the lobby is stocked with Delivery Confirmation™ and Signature Confirmation™ retail labels	*Dates that indicate last date to mail are dependent on drop-off location, time, and destination.			

MAY STAMP RELEASES:

- Peanuts
- Honoring Veterans

Refer to your 90-Day Retail Calendar Poster for additional information.

Access the Retail Intranet Site at: <http://retail.usps.gov>

What's in Store

your

Retail Calendar

'01
SUMMER

June

					FRI	SAT
SUN	MON	TUE	WED	THU	1	2
3	4	5	6	7	8	9
Did You Know? Frida Kahlo is believed to be the first female artist to sell a piece of art to the Louvre		Inform Your Customers that they can generate Father's Day greeting cards through NetPost™ CardStore available online	Vending Reminder: Refer to the Self Service Intranet Web page for the latest vending news at retail.usps.gov ®	Inform Your Customers that Signature Confirmation™ service lets them know who has signed for their package	<i>payday</i>	Vending Reminder: Clean your validators regularly — don't wait for failures. Refer to MMO-056 00, Ardac Validator Cleaning Instructions, 6/2/00
10	11	12	13	14	15	16
Did You Know? Taking into account inflation, stamps have cost between 20 and 40 cents since the Postal Service began	<i>Summer/Fall POP and Merchandise shipments arrive this week</i>		Vending Reminder: Have you seen the CD on validator cleaning? Check out the February SSSPC Tech quarterly for more information	Last day for Priority Mail® service to arrive by Father's Day* <i>Flag Day</i>	Vending Reminder: Use the PHASE II Information Transfer Units (ITUs) to reprofile all vending equipment validators at servicing	Last day for Express Mail® service to arrive on Father's Day* AP 11 begins
17	18	19	20	21	22	23
<i>Father's Day</i>	<i>Summer/Fall Drive Period Begins — Make sure POP and merchandise are properly displayed</i> Visa® Promotion begins		Vending Reminder: See the Self Service Intranet Web page to learn about the newly released "Validator Cleaning Procedures" CD	<i>First Day of Summer</i>	<i>payday</i>	Retail Reminder: Move outdated merchandise to a secondary location
24	25	26	27	28	29	30
Did You Know? The all-time most popular commemorative stamp was the Elvis Presley stamp issued in 1993	Inform Your Customers that they can manage their bills online with USPS eBillPay™ at www.usps.com ®	Make sure Holiday Closing door sign is displayed	Vending Reminder: How many validators did you return to Topeka this month? Did you include your FEDSTRIP number? If not, you will not get proper credit	Inform Your Vacationing Customers that postcard stamps are available in books and coils	Retail Reminder: Last day for Districts to input VESS data for AP 10	Retail Reminder: Don't forget to check the lobby sales bin, remove trash, and restock merchandise

JUNE STAMP RELEASES:

- **Frida Kahlo**

*Dates that indicate last date to mail are dependent on drop-off location, time, and destination.

Refer to your 90-Day Retail Calendar Poster for additional information.

Access the Retail Intranet Site at: <http://retail.usps.gov>

What's in Store

your

Retail Calendar

'01
SUMMER

July

SUN	MON	TUE	WED	THU	FRI	SAT
1 Did You Know? It took Thomas Jefferson only 2 days to write the Declaration of Independence	2 Retail Reminder: Our goal is to list 100% of all Certified Retail Coaches by AP 11. Check out the site at http://rpsweb.usps.gov/coaches/home.asp *	3 Vending Reminder: Refer to the Ardac Validator Cleaning Instructions for your Ardac validators	4 Offices Closed <i>Independence Day</i>	5 Retail Reminder: It's summertime, so arrange child-related merchandise on the slatwall where kids can see it.	6 <i>payday</i>	7 Vending Reminder: Refer to the Self Service Intranet Web page for the latest vending news at retail.usps.gov *
8 Did You Know? Last fiscal year, we had a net revenue of \$30.5 million from packaging products	9 Inform Your Customers that Signature Confirmation™ is available for Priority Mail® and Parcel Post	10	11 	12 Select Locations: Look for new Continuity POP menuboards and hardware	13 Vending Reminder: See the Self Service Intranet Web page to learn about the newly released "Validator Cleaning Procedures" CD	14 AP 12 begins
15 Did You Know? Last fiscal year, we had a net revenue of \$5.7 million from retail merchandise	16 Inform Your Small Business Customers the special features of our premier international service, Global Express Guaranteed™, can be accessed online at www.usps.com *	17 Retail Reminder: The mail pick-up function on your POS ONE system can also be used to scan Vacation Hold mail	18	19 Vending Reminder: Use the PHASE II Information Transfer Units (ITUs) to reprofile <i>all</i> vending equipment validators at servicing	20 <i>payday</i>	21 Vending Reminder: How many validators did you return to Topeka this month? Did you include your FEDSTRIP number? If not, you will not get proper credit
22 Did You Know? Last fiscal year, we had a net revenue of \$5.3 million from FIRSTCLASS PHONECARDS®	23 Retail Reminder: The rules for nonstandard surcharge also apply to international mail	24	25 Inform Your Vacationing Customers that postcard stamps are available in books and coils	26	27 Retail Reminder: Last day for Districts to input VESS data for AP 11	28
29 Did You Know? You can check out the Postal Store at www.usps.com	30 Vending Reminder: Vending Items 669700 and 669711, Apples and Oranges, wave 2 distribution 7/30-8/29	31 Vending Reminder: Clean your validators regularly — don't wait for failures. Refer to MM0-056 00, Ardac Validator Cleaning Instructions, 6/2/00	JULY STAMP RELEASES: • Leonard Bernstein • Baseball's Legendary Playing Fields			

Refer to your 90-Day Retail Calendar Poster for additional information.

Access the Retail Intranet Site at: <http://retail.usps.gov>

VENDING SERVICING EMPLOYEES

FIRSTCLASS PHONECARD® — New Vending-Exclusive Phone Card

A new vending-exclusive FIRSTCLASS PHONECARD has been produced. The new \$10 40-minute vending FIRSTCLASS PHONECARD:

- Features the 2001 “Farm Flag” stamp.
- Offers a lower per-minute rate than the former \$10 30-minute and the \$20 60-minute versions.
- Reduces the amount of change that the equivalent \$8 30-minute version would require.
- Will be available *only* through Postal Service vending machines.
- Will be the *only* denomination available through vending.
- Frees up a selection to dispense an additional product where two selections were used previously.

Beginning the week of May 14, 2001, all vending employees currently servicing machines that dispense the FIRSTCLASS PHONECARD will receive an automatic shipment of the new vending-exclusive phone cards and facsimiles. Specific switch-out instructions (page 67) and the *Inventory Destruction Form — Vending Servicing* (page 68) are provided. Complete the changeover by June 30, 2001.

Instructions for the New Vending-Exclusive Phone Card

The switch-out process:

- Remove previous FIRSTCLASS PHONECARD (FCPC) versions.
- Deactivate previous FCPC versions.
- Destroy previous FCPC versions.
- Activate new FCPC vending inventory.
- Load new FCPC inventory in selection C-1.
- Load an additional product in selection C-2 by reducing FCPC from two selections to one.
- Replace FCPC facsimiles.
- Program new prices into the machine for the two selections.

Switch-out instructions for changing out the machine:

- Batch activate new FCPCs prior to loading the machine (Ref. Pub 211, 3-1.3).
- Remove old inventory.
- \$8 30-min. Aquarium Fish
- \$10 30-min. Aquarium Fish
- \$20 60-min. 20th Century Limited Train
- \$20 60-min. Victorian Love
- Fill only C1 selection with the new \$10 40-min. phone cards (Ref. Pub 211, 4-2).
- Fill the C2 selection with another product.
- Insert new FCPC facsimile into the C1 Product Identifier.
- Change the facsimile for the C2 selection to coordinate with the new product.

Inventory destruction instructions for deactivating and destroying the old cards:

- The following FCPCs packaged for vending are authorized to be destroyed:

\$8 Aquarium Fish	\$10 Aquarium Fish	\$20 20 th Century Train	\$20 Victorian Love
-------------------------	--------------------------	---	---------------------------

- Gather all phone cards listed above that have been removed from machines and back stock.
- Individually deactivate all phone cards that have been removed from machines or previously activated by calling 1-800-658-4039 and following the FCPC voice prompts. You may deactivate batches *only* if the batch is unbroken. (Destroying activated phone cards will result in the Postal Service paying for phone cards that were never sold.)
- List the "Quantity" of each dollar denomination on the Inventory Destruction Form.
- Enter the "Total \$ Value" for each "\$ Denomination" at the end of the row.
- Enter the "Grand Total" at the bottom of the "Total \$ Value" column.
- Carefully cut each phone card in half or shred. (Be certain that the PIN and control numbers found on the bottom of the card are separated by the cut.)
- Sign and have a witness sign the Inventory Destruction Form to verify that the listed inventory has been destroyed.
- Send or fax a copy of the form as noted on the bottom of the Inventory Destruction Form.
- Keep the original copy of the form on file in your office for 2 years.

Copies of Publication 211, *FCPC Self-Service Guide*, may be downloaded from the intranet at <http://blue.usps.gov/cpim/ftp/pubs/pub211.pdf>.

— *Self Service, Retail, Consumers and Small Business, 5-3-01*

CUT ALONG DOTTED LINE



FIRSTCLASS PHONECARD®

Inventory Destruction Form — Vending Servicing

Date _____

Location Destroying FIRSTCLASS PHONECARDS:

Unit Name _____ District Finance # _____

Address _____ Unit SFA # _____

City _____ State _____ ZIP+4 _____

\$ Denomination	Quantity	Total \$ Value
<i>Example: \$20 item</i>	<i>15</i>	<i>\$300</i>
\$8 Aquarium Fish		
\$10 Aquarium Fish		
\$20 20 th Century Limited Train		
\$20 Victorian Love		
Grand Total		

**Note: All cards must be deactivated before they are destroyed.
Cards not deactivated will be charged to the Postal Service by AT&T.**

Attested: _____ Witnessed: _____

Signature: _____ Signature: _____

Name: _____ Name: _____

Fax/send a copy to:

RMC
 PHONECARD DESTRUCTION
 11230 OLIVE AVE SUITE #106
 ST LOUIS MO 63141-7161
 FAX: 1-888-558-4329

Keep original copy on file in office for 2 years.





This office
will be closed
Monday,
May 28, 2001,
to observe
Memorial Day.



This page intentionally left blank

This page intentionally left blank



475 L'ENFANT PLAZA SW
WASHINGTON DC 20260-5540

First-Class Mail
Postage & Fees Paid
USPS
Permit No. G-10

Postal Bulletin Distribution

Postal Service Orders for Postal Bulletin

- New Order Change of Address/Quantity
(Include *Postal Bulletin* mailing label.)

Attention Line

Postal Facility Name

Delivery Address

City State ZIP+4

Person to Contact
()

Daytime Telephone

Current Quantity _____ New Quantity _____

Missing Issues: If postal facilities that receive the *Bulletin* from GPO do not receive their order, they should call the *Postal Bulletin* editor at 202-268-2836. All other facilities should contact their administrative post office.

Address and Quantity Changes and Subscription Problems: Postal facilities may send address and quantity changes and subscription queries via cc:Mail to POSTAL BULLETIN or via the Internet to *pbulleti@email.usps.gov*. Please include old and new address and quantities, and the "POO" subscription number from your address label. Postal facilities may also complete this form and mail it to:

ATTN POSTAL BULLETIN
US POSTAL SERVICE
475 L'ENFANT PLZ SW RM 5540
WASHINGTON DC 20260-5540

All other facilities should contact their administrative post office.

Single Copies (back to 1 year): To order extra copies or back issues (see Table of Contents for specific PSN), use MDC Touch Tone Order Entry by calling 800-332-0317 (option 1, then option 2) or send PS Form 7380, *MDC Supply Requisition*, to:

MATERIAL DISTRIBUTION CENTER
ATTN SUPPLY REQUISITIONS
500 SW GARY ORMSBY DR
TOPEKA KS 66624-9602

Public Orders for Postal Bulletin

- New Order Change of Address
(Include *Postal Bulletin* mailing label.)

Attention Line

Company Name

Delivery Address

City State ZIP+4
()

Daytime Telephone



Subscription: Domestic - \$140.00 per year; International - \$175.00 per year

Subscription Orders: 202-512-1800

Subscription Inquiries: 202-512-1806 Fax: 202-512-2250

Single Copies (back to 16 issues): Domestic - \$10.00; International - \$12.50

- Enter _____ Annual Subscription(s).
Total Amount \$ _____
- Send _____ additional copies of *Bulletin* # _____
Total Amount \$ _____
- GPO deposit account -
- Check/money order payable to: Superintendent of Documents

- VISA  MasterCard 

Credit Card Number

Expiration Date

Signature

Mail Completed Form and Payment To:

SUPERINTENDENT OF DOCUMENTS
US GOVERNMENT PRINTING OFFICE
PO BOX 371954
PITTSBURGH PA 15250-7954